

PORTAIL ALUMINIUM

ALUMINIUM GATES

Portail à Battant

Portillon

Portail Coulissant

Modèles

Clôtures

Clôtures et Brise-vue en kit

Modules complémentaires

PORTAIL À BATTANT

Caractéristiques

- Section du montant 120x64mm, ou 80x43mm pour le modèle Lot et Gamme Performance ONE
- Section de la traverse 80x40mm
- Triple fixation longitudinale et transversale par visserie inox
- Peinture label Qualicoat / Qualimarine / Qualanod
- Quincaillerie INOX / ALU laquée
- Bague laiton
- Double battue centrale avec joint epdm
- Assemblage mécano assemblé par emboitement
- Aluminium 100% recyclable



PORTILLON

Caractéristiques

- Section du montant 120x64mm, ou 80x43mm pour le modèle Lot et Gamme Performance ONE
- Section de la traverse 80x40mm
- Triple Fixation longitudinale et transversale par visserie inox
- Peinture label Qualicoat / Qualimarine / Qualanod
- Quincaillerie INOX/ALU laquée
- Bague laiton
- Assemblage mécano assemblé par emboitement
- Aluminium 100% recyclable



PORTAIL COULISSANT

Caractéristiques

- Section du montant 120x64mm, ou 80x43mm pour le modèle Lot et Gamme Performance ONE
- Section de la traverse 80x40mm
- Triple Fixation longitudinale et transversale par visserie inox
- Peinture label Qualicoat / Qualimarine / Qualanod
- Quincaillerie INOX/ALU laquée
- Assemblage mécano assemblé par emboitement
- Double Galet nylon sur roulement à billes, rail aluminium anodisé, butée au sol, guidage roulette nylon, tulipe de réception, cache crémaillère
- Aluminium 100% recyclable

Portail Aluminium

FICHE TECHNIQUE

Résistance
au VENT



C5



Résistance au vent: C5
EN 13241-1
Wind resistance: C5
EN 13241-1

Panneau sandwich

Remplissage sur les modèles

LOT, TARN, DIJON VERTICAL, DIJON HORIZONTAL, PERFORMANCE ONE

- Augmente l'efficacité énergétique
- Diminution du poids du portail
- "ALUCOBOND® PLUS est un panneau composite constitué de deux tôles d'aluminium avec un noyau minéral."
- Poids du panneau [kg/m²]: 7,6
- Epaisseur des tôles de recouvrement: 0,5 mm

Comportement au feu:

- UE: EN EN 13501-1; Classe B-s1, d0
- Suisse: VKF; RF2
- Test incendie majeur: Lepir 2; classement obtenu

Noyau à remplissage minéral

- 0,5mm aluminium

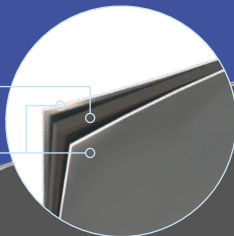

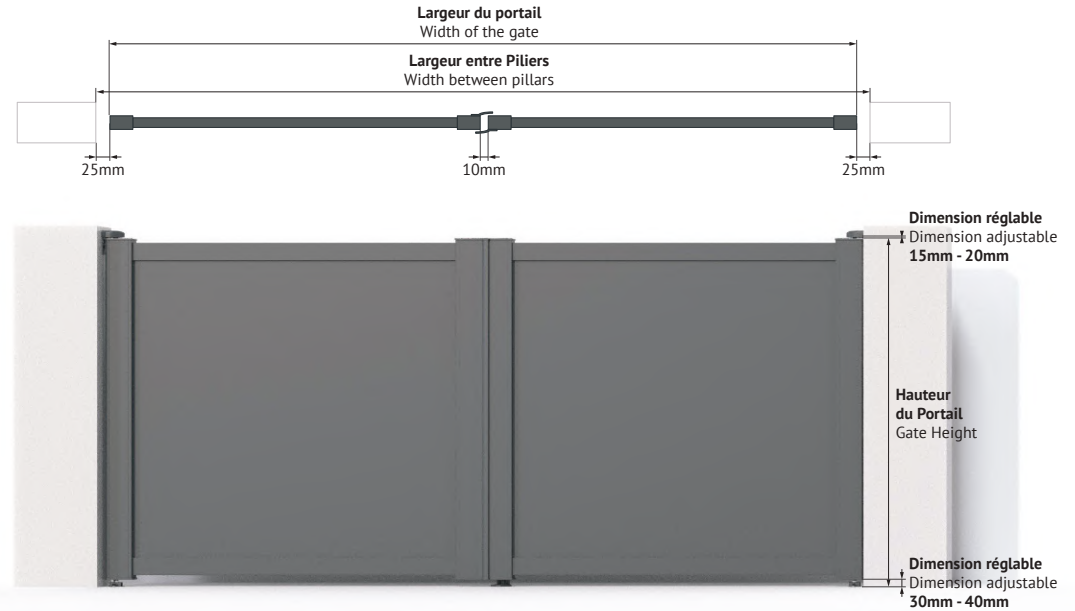

DIFICILEMENT INFLAMMABLE

PORTAIL À BATTANT



Accessoires inclus | Accessories included

| | | |
|---|--|---|
| <p>Crapaudines acier Steel Pivot Bearings</p>  | <p>Gond acier avec capuchon plastique Steel Bracket with plastic cover</p>  | <p>Poignée, cylindre et Serrure pour option portail manuel Handle, cylinder and locking for the manual gate option</p>  |
| <p>Sabot pour portail motorisé Stop block for motorized gate</p>  | <p>Sabot pour option portail manuel Stop block for the manual gate option</p>  | <p>Arrêts automatiques pour option portail manuel Automatic gate holders for the manual gate option</p>  |

PORTILLON

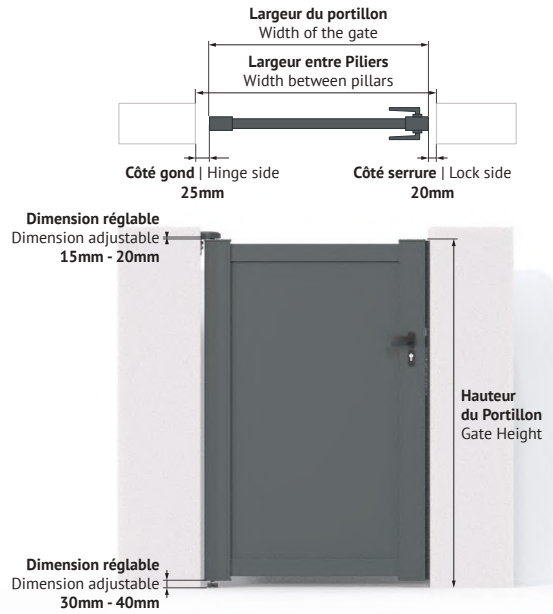

PORTAIL COULISSANT

PORTAIL À MOTORISÉ GENERAL MOTORIZED GENERAL GATE

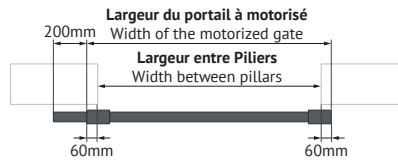

PORTAIL À MOTORISÉ MOTORIZED GATE LOT/PERFORMANCE ONE

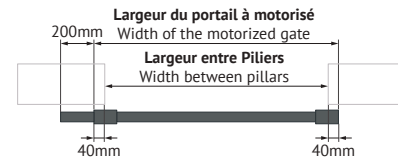

TOUTS PORTAILS MANUEL ALL MANUAL GATES

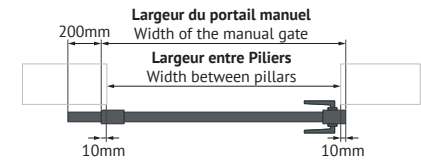

Accessoires inclus | Accessories included

Gond acier avec capuchon plastique
Steel Bracket with plastic cover



Poignée et cylindre
Handle with cylinder



Crapaudines acier
Steel Pivot Bearings



Grande battue avec gâche
Large stop with striking plate

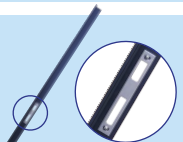

Accessoires inclus | Accessories included

Équerre de guidage (triple roulette)
Guide rollers (triple roller)



Rail au sol
Track

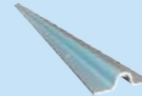

Arrêt d'ouverture
Gate stopper



Double Galet nylon avec roulement à billes
Double Nylon rollers with ball bearing



Poignée, cylindre et Serrure pour op. portail manuel
Handle, cylinder and locking for the manual gate option



Tulipe de réception avec guide pour portail motorisé
Gate holder with guide for motorized gate



Battue de réception pour option portail manuel
Gate Stop for the manual gate option

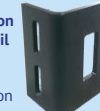

Crémaillère en nylon
Nylon rack



Modèles | Models

AIN

PORTILLON
GARDEN DOOR



PORTAIL BATTANT
WINGED GARDEN GATE



PORTAIL COULISSANT
SLIDING GATE

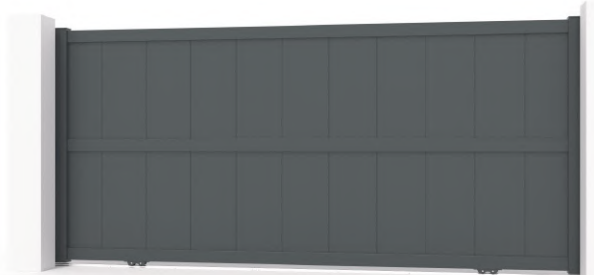

Modèles | Models

AUDE



Lames | Slats
30x15mm

PORTILLON
GARDEN DOOR



PORTAIL BATTANT
WINGED GARDEN GATE



PORTAIL COULISSANT
SLIDING GATE



Modèles | Models

CALVADOS

PORTILLON
GARDEN DOOR



PORTAIL BATTANT
WINGED GARDEN GATE



PORTAIL COULISSANT
SLIDING GATE

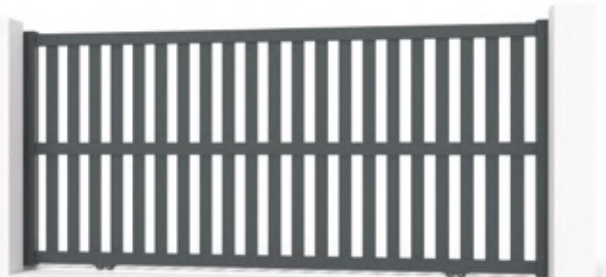

Modèles | Models

CANTAL



PORTILLON
GARDEN DOOR



PORTAIL BATTANT
WINGED GARDEN GATE



PORTAIL COULISSANT
SLIDING GATE

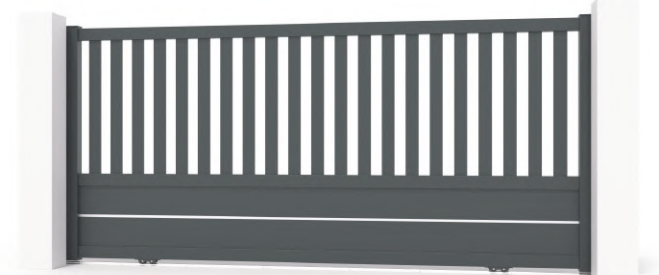

Modèles | Models

CHER

PORTILLON
GARDEN DOOR



PORTAIL BATTANT
WINGED GARDEN GATE

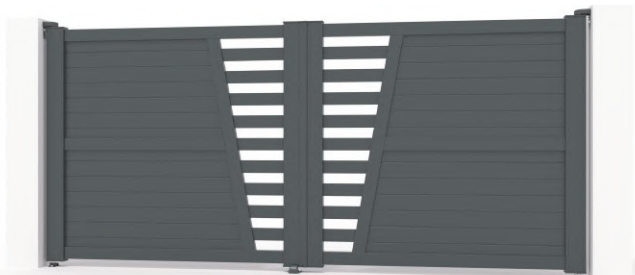

PORTAIL COULISSANT
SLIDING GATE

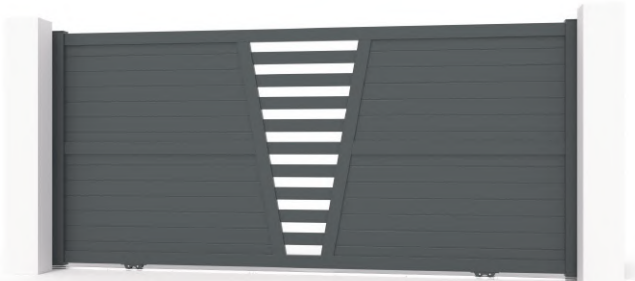

Modèles | Models

DIJON HORIZONTAL

PORTILLON
GARDEN DOOR



PORTAIL BATTANT
WINGED GARDEN GATE



PORTAIL COULISSANT
SLIDING GATE



Panneau sandwich
Sandwich panel
3mm

Modèles | Models

DIJON PANNEAU

PORTILLON
GARDEN DOOR



PORTAIL BATTANT
WINGED GARDEN GATE



PORTAIL COULISSANT
SLIDING GATE

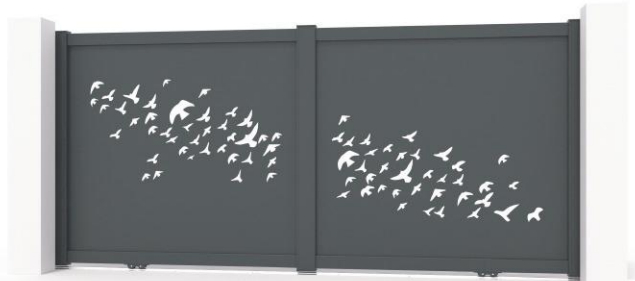

Panneau aluminium
Aluminium panel
3mm

Option décor sur le panneau (Voir page 079)
Decor on the panel as option (See from page 079)

Modèles | Models

DIJON VERTICAL

PORTILLON
GARDEN DOOR



PORTAIL BATTANT
WINGED GARDEN GATE



PORTAIL COULISSANT
SLIDING GATE



Panneau sandwich
Sandwich panel
3mm

Option décor alunox sur le panneaux (Voir page 075)
Decor alunox on the panel as option (See from page 075)

Modèles | Models

GARD

PORTILLON
GARDEN DOOR



PORTAIL BATTANT
WINGED GARDEN GATE

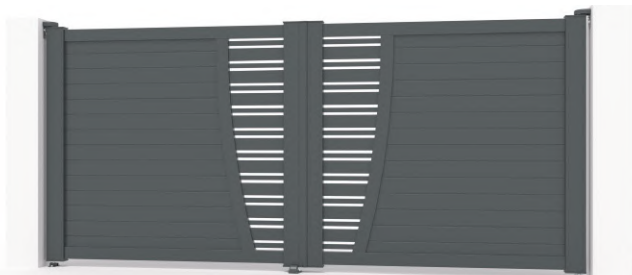

PORTAIL COULISSANT
SLIDING GATE

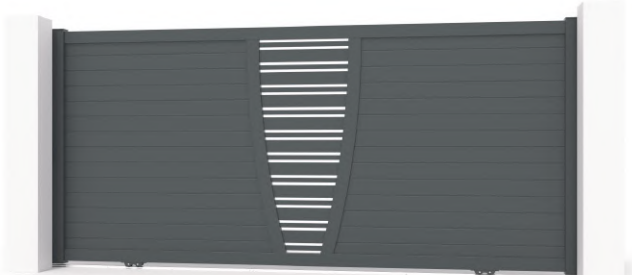

Modèles | Models

INDRE

PORTILLON
GARDEN DOOR



PORTAIL BATTANT
WINGED GARDEN GATE



PORTAIL COULISSANT
SLIDING GATE

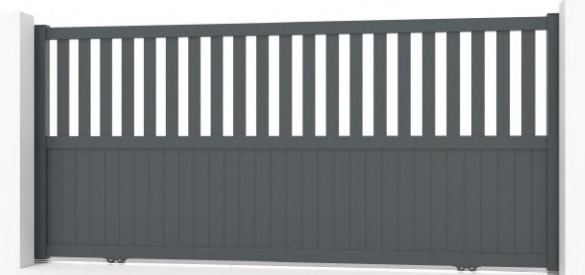

Modèles | Models

ISÈRE

PORTILLON
GARDEN DOOR



PORTAIL BATTANT
WINGED GARDEN GATE



PORTAIL COULISSANT
SLIDING GATE



Modèles | Models

JURA



Lames | Slats
100x15mm

PORTILLON
GARDEN DOOR



PORTAIL BATTANT
WINGED GARDEN GATE



PORTAIL COULISSANT
SLIDING GATE

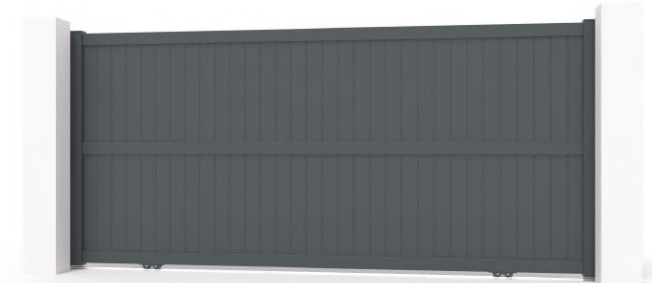

Modèles | Models

LANDES

PORTILLON
GARDEN DOOR



PORTAIL BATTANT
WINGED GARDEN GATE



PORTAIL COULISSANT
SLIDING GATE

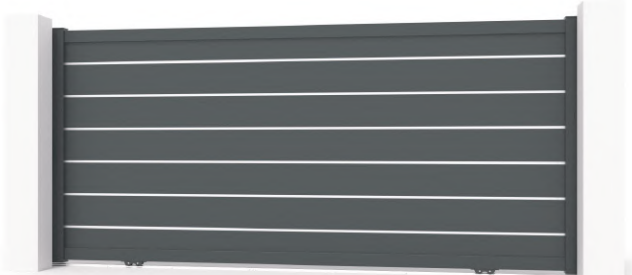

Modèles | Models

LANDES DOUBLE

PORTILLON
GARDEN DOOR



PORTAIL BATTANT
WINGED GARDEN GATE



PORTAIL COULISSANT
SLIDING GATE



Modèles | Models

LANDES OBLIQUE

PORTILLON
GARDEN DOOR



PORTAIL BATTANT
WINGED GARDEN GATE



PORTAIL COULISSANT
SLIDING GATE

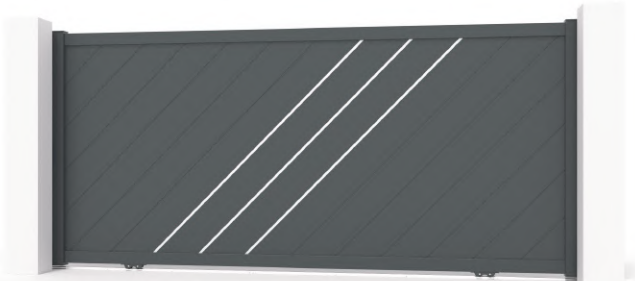

Modèles | Models

LANDES VERTICALE



Lames | Slats
200x15mm, 35x12mm

PORTILLON
GARDEN DOOR



PORTAIL BATTANT
WINGED GARDEN GATE



PORTAIL COULISSANT
SLIDING GATE

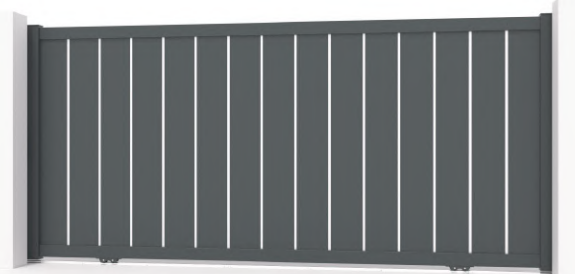

Modèles | Models

LOT

PORTILLON
GARDEN DOOR



PORTAIL BATTANT
WINGED GARDEN GATE



PORTAIL COULISSANT
SLIDING GATE



Modèles | Models

MANCHE



PORTILLON
GARDEN DOOR



PORTAIL BATTANT
WINGED GARDEN GATE



PORTAIL COULISSANT
SLIDING GATE



Modèles | Models

MARNE

PORTILLON
GARDEN DOOR



PORTAIL BATTANT
WINGED GARDEN GATE



PORTAIL COULISSANT
SLIDING GATE



Lames | Slats
30x15mm

Le Portail battant et le Portail coulissant comportent deux décors et le Portillon comporte un décor (Voir page 061)
The Winged garden gate and Sliding garden gate take two decors and the garden door takes one decor (See from page 061)

Modèles | Models

NORD



Aile d'avion
Elliptical louvre
100mm

Lames | Slats
100x15mm

PORTILLON
GARDEN DOOR



PORTAIL BATTANT
WINGED GARDEN GATE



PORTAIL COULISSANT
SLIDING GATE



Modèles | Models

NORD TOTAL

PORTILLON
GARDEN DOOR



PORTAIL BATTANT
WINGED GARDEN GATE



PORTAIL COULISSANT
SLIDING GATE



Modèles | Models

NÉO VISION



Lames | Slats
200x15mm

Le Portail battant comporte deux décors et le Portillon et le Portail coulissant comportent un décor (Voir page 061)
The Winged garden gate takes two decors and the garden door and the Sliding garden gate take one decor (See from page 061)

PORTILLON
GARDEN DOOR



PORTAIL BATTANT
WINGED GARDEN GATE



PORTAIL COULISSANT
SLIDING GATE



Modèles | Models

NÉO VISION HORIZONTAL

PORTILLON
GARDEN DOOR



PORTAIL BATTANT
WINGED GARDEN GATE



PORTAIL COULISSANT
SLIDING GATE

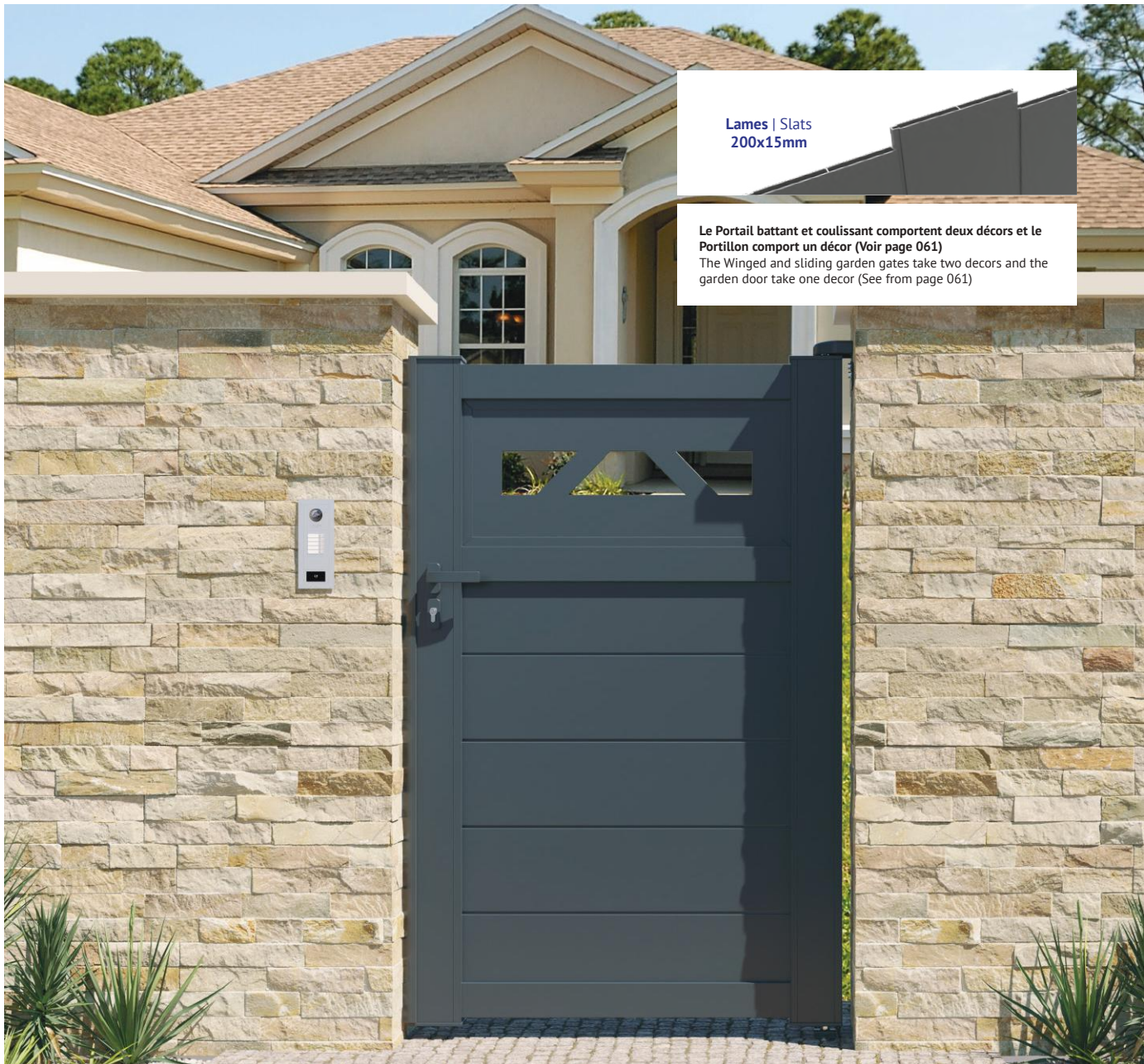

Lames | Slats
200x15mm

Le Portail battant et coulissant comportent deux décors et le Portillon comport un décor (Voir page 061)
The Winged and sliding garden gates take two decors and the garden door take one decor (See from page 061)

Modèles | Models

NÉO VISION OBLIQUE

Lames | Slats
200x15mm

Le Portail battant et coulissant et portillon comportent un décor (Voir page 061)
The Winged and sliding garden gates and the garden door take one decor (See from page 061)

PORTILLON
GARDEN DOOR



PORTAIL BATTANT
WINGED GARDEN GATE



PORTAIL COULISSANT
SLIDING GATE



Modèles | Models

NÉO VISION TRI-ANGLE

PORTILLON
GARDEN DOOR



PORTAIL BATTANT
WINGED GARDEN GATE



PORTAIL COULISSANT
SLIDING GATE



Lames | Slats
200x15mm

Le Portail battant comporte deux décors et le Portillon et le Portail coulissant comportent un décor (Voir page 067)
The Winged garden gate takes two decors and the garden door and the Sliding garden gate take one decor (See from page 067)

Modèles | Models

NÉO VISION TRI-CENTRAL



Lames | Slats
200x15mm

Le Portail battant comporte deux décors et le Portillon et le Portail coulissant comportent un décor (Voir page 067)
The Winged garden gate takes two decors and the garden door and the Sliding garden gate take one decor (See from page 067)

PORTILLON
GARDEN DOOR



PORTAIL BATTANT
WINGED GARDEN GATE



PORTAIL COULISSANT
SLIDING GATE



Modèles | Models

OISE

PORTILLON
GARDEN DOOR



PORTAIL BATTANT
WINGED GARDEN GATE

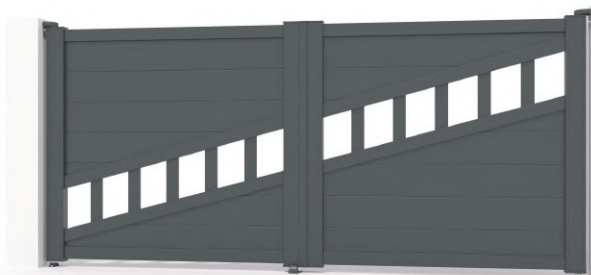

PORTAIL COULISSANT
SLIDING GATE

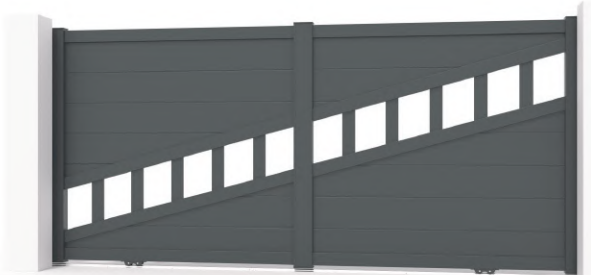

Modèles | Models

STRONG AJOURÉ



Lames | Slats
150x40mm

PORTILLON
GARDEN DOOR



PORTAIL BATTANT
WINGED GARDEN GATE



PORTAIL COULISSANT
SLIDING GATE

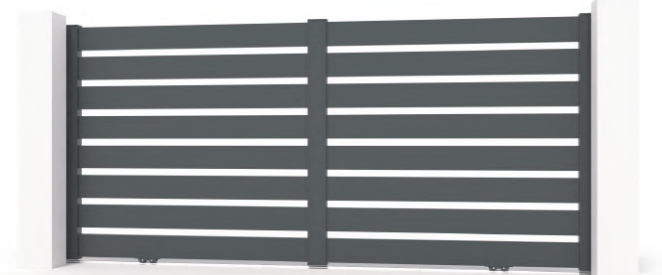

Modèles | Models

STRONG PERSIENNE

PORTILLON
GARDEN DOOR



PORTAIL BATTANT
WINGED GARDEN GATE



PORTAIL COULISSANT
SLIDING GATE



Modèles | Models

STRONG PLEIN

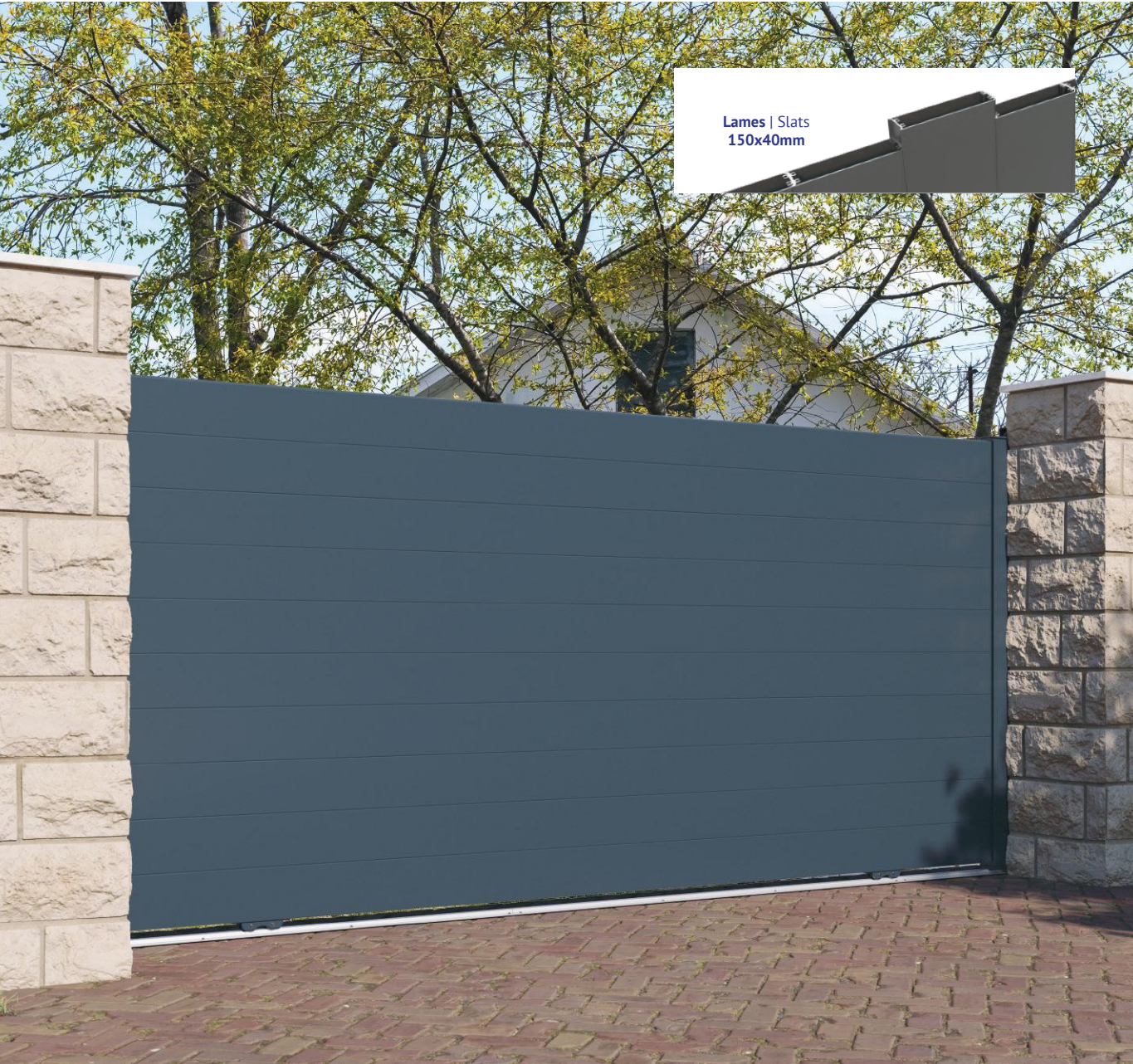

Lames | Slats
150x40mm

PORTILLON
GARDEN DOOR



PORTAIL BATTANT
WINGED GARDEN GATE



PORTAIL COULISSANT
SLIDING GATE



Modèles | Models

TARN

PORTILLON
GARDEN DOOR



PORTAIL BATTANT
WINGED GARDEN GATE

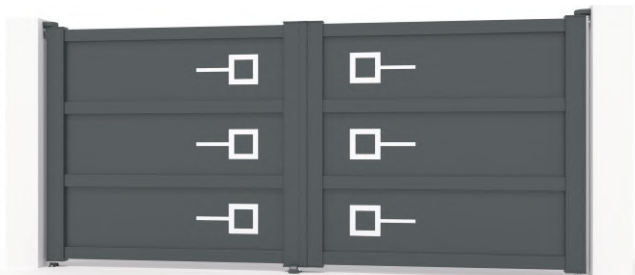

PORTAIL COULISSANT
SLIDING GATE

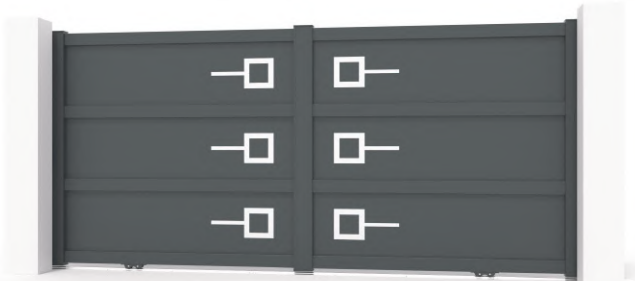

Panneau sandwich
Sandwich panel
3mm

Option décor alunox sur le panneaux (Voir page 073)
Decor alunox on the panel as option (See from page 073)

Modèles | Models

YONNE



PORTILLON
GARDEN DOOR



PORTAIL BATTANT
WINGED GARDEN GATE

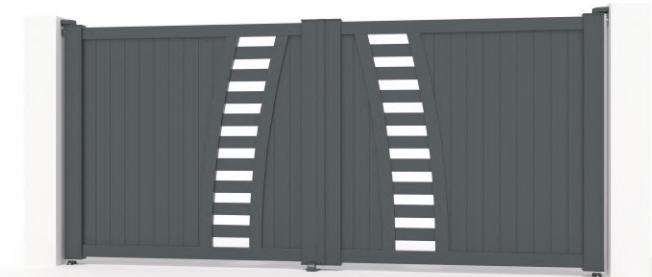

PORTAIL COULISSANT
SLIDING GATE

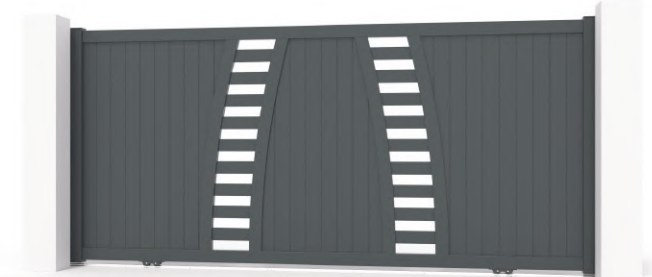

Modèles | Models

ARBRE DE LA VIE

PORTILLON
GARDEN DOOR



PORTAIL BATTANT
WINGED GARDEN GATE



PORTAIL COULISSANT
SLIDING GATE



Modèles | Models

ROSE DES VENTS

PORTILLON
GARDEN DOOR



PORTAIL BATTANT
WINGED GARDEN GATE

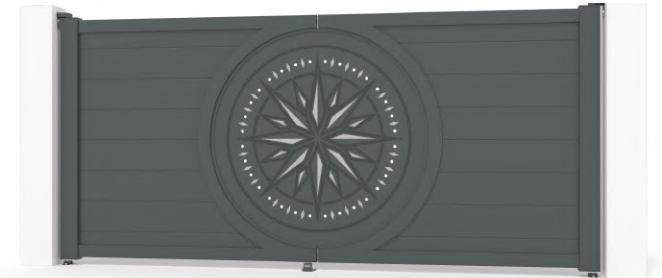

PORTAIL COULISSANT
SLIDING GATE

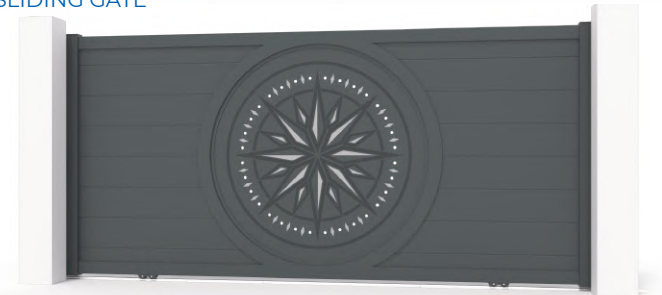

Lames | Slats
200x15mm

Modèles | Models

PERFORMANCE ONE BOLOGNA

PORTILLON
GARDEN DOOR



PORTAIL BATTANT
WINGED GARDEN GATE



PORTAIL COULISSANT
SLIDING GATE

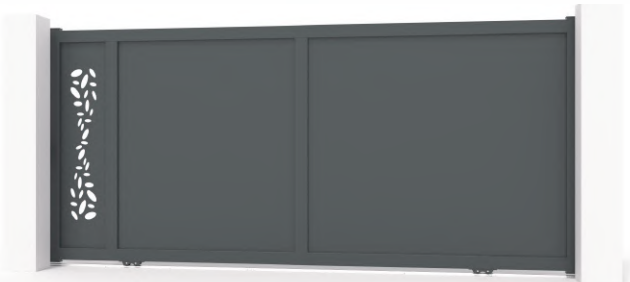

Panneau sandwich
Sandwich panel
3mm

Le Portail battant comporte deux décors et le Portillon et le Portail coulissant comportent un décor (Voir page 061)
The Winged garden gate takes two decors and the garden door and the Sliding garden gate take one decor (See from page 061)

Modèles | Models

PERFORMANCE ONE BOLOGNA INVERSÉ

PORTILLON GARDEN DOOR



PORTAIL BATTANT WINGED GARDEN GATE



PORTAIL COULISSANT SLIDING GATE

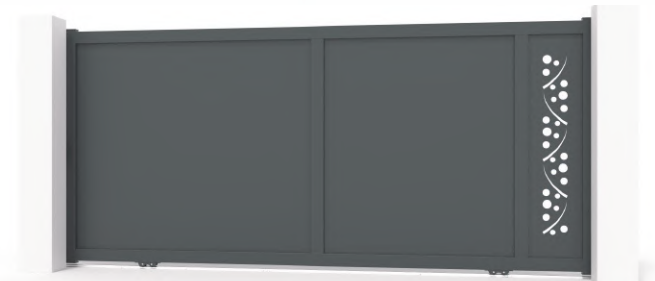

Panneau sandwich
Sandwich panel
3mm

Le Portail battant comporte deux décors et le Portillon et le Portail coulissant comportent un décor (Voir page 061)
The Winged garden gate takes two decors and the garden door and the Sliding garden gate take one decor (See from page 061)

Modèles | Models

PERFORMANCE ONE

BOLOGNA HORIZONTAL

PORTILLON
GARDEN DOOR



PORTAIL BATTANT
WINGED GARDEN GATE



PORTAIL COULISSANT
SLIDING GATE



Panneau sandwich
Sandwich panel
3mm

Le Portail battant et coulissant comportent deux décors et le Portillon comport un décor (Voir page 061)
The Winged and sliding garden gates take two decors and the garden door take one decor (See from page 061)

Modèles | Models

PERFORMANCE ONE CATANIA

PORTILLON GARDEN DOOR



PORTAIL BATTANT WINGED GARDEN GATE



PORTAIL COULISSANT SLIDING GATE

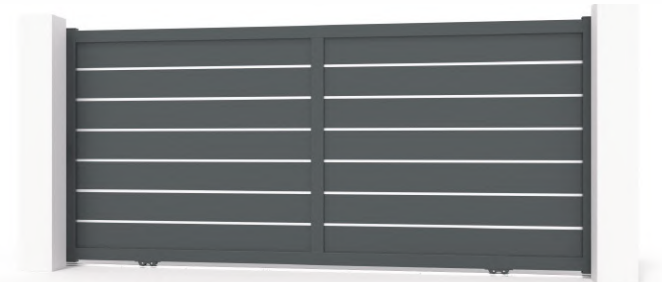

Panneau sandwich
Sandwich panel
3mm



Modèles | Models

PERFORMANCE ONE

FERRARA

PORTILLON
GARDEN DOOR



PORTAIL BATTANT
WINGED GARDEN GATE

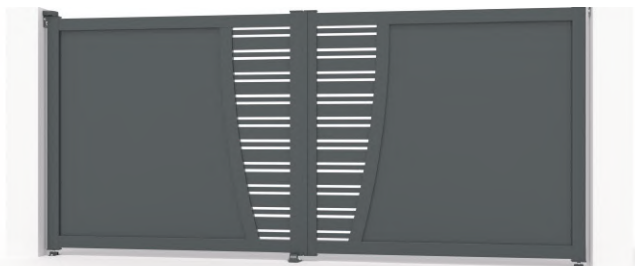

PORTAIL COULISSANT
SLIDING GATE

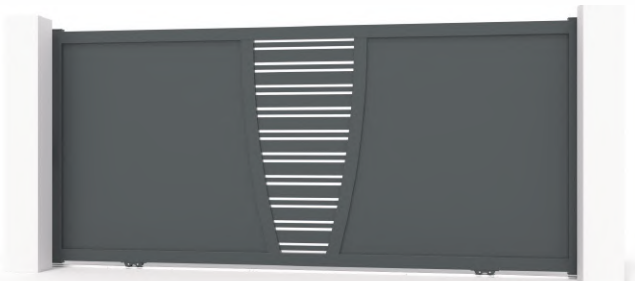

Modèles | Models

PERFORMANCE ONE FIRENZE

PORTILLON GARDEN DOOR



PORTAIL BATTANT WINGED GARDEN GATE



PORTAIL COULISSANT SLIDING GATE



Panneau sandwich
Sandwich panel
3mm

Modèles | Models

PERFORMANCE ONE

GENOVA

PORTILLON
GARDEN DOOR



PORTAIL BATTANT
WINGED GARDEN GATE



PORTAIL COULISSANT
SLIDING GATE

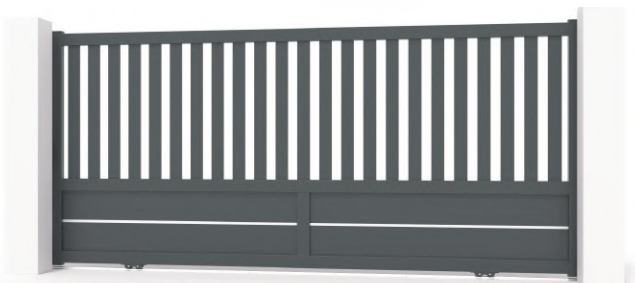

Lames | Slats
80x15mm

Panneau sandwich
Sandwich panel
3mm

Modèles | Models

PERFORMANCE ONE MESSINA

PORTILLON GARDEN DOOR



PORTAIL BATTANT WINGED GARDEN GATE



PORTAIL COULISSANT SLIDING GATE

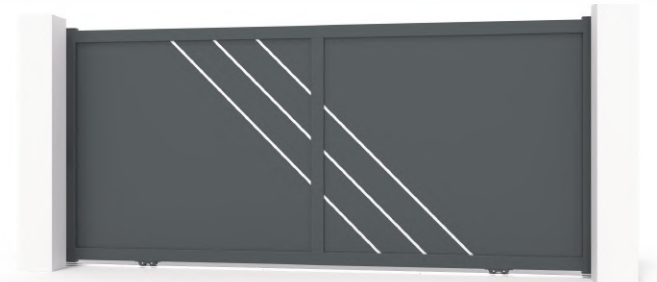

Modèles | Models

PERFORMANCE ONE MODENA

PORTILLON
GARDEN DOOR



PORTAIL BATTANT
WINGED GARDEN GATE

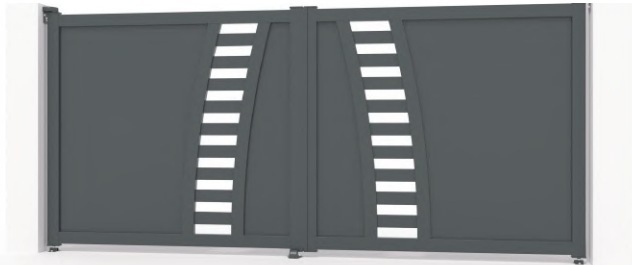

PORTAIL COULISSANT
SLIDING GATE

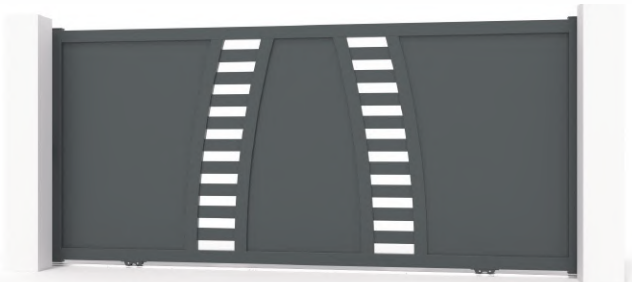

Lames | Slats
80x15mm

Panneau sandwich
Sandwich panel
3mm

Modèles | Models

PERFORMANCE ONE MONZA

PORTILLON GARDEN DOOR



PORTAIL BATTANT WINGED GARDEN GATE



PORTAIL COULISSANT SLIDING GATE



Aile d'avion
Elliptical louvre
100mm

Panneau sandwich
Sandwich panel
3mm

Modèles | Models

PERFORMANCE ONE NAPOLI

PORTILLON
GARDEN DOOR



PORTAIL BATTANT
WINGED GARDEN GATE



PORTAIL COULISSANT
SLIDING GATE

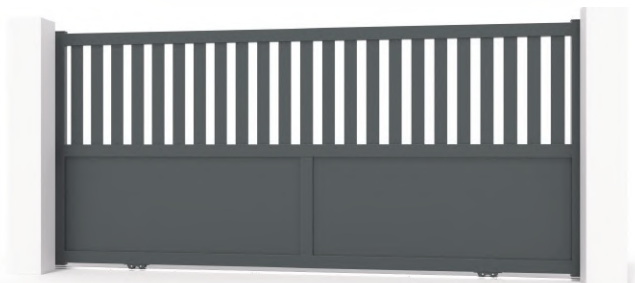

Lames | Slats
80x15mm

Panneau sandwich
Sandwich panel
3mm

Modèles | Models

PERFORMANCE ONE ROMA

PORTILLON GARDEN DOOR



PORTAIL BATTANT WINGED GARDEN GATE



PORTAIL COULISSANT SLIDING GATE

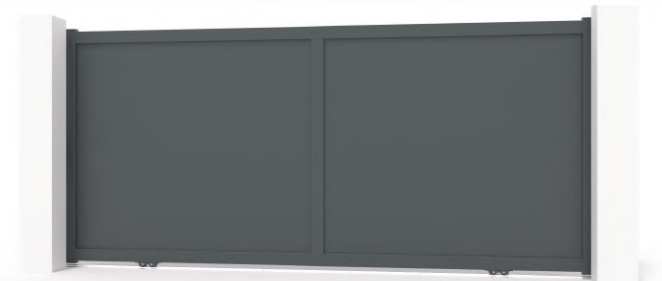

Modèles | Models

PERFORMANCE ONE

TARANTO

PORTILLON
GARDEN DOOR



PORTAIL BATTANT
WINGED GARDEN GATE



PORTAIL COULISSANT
SLIDING GATE

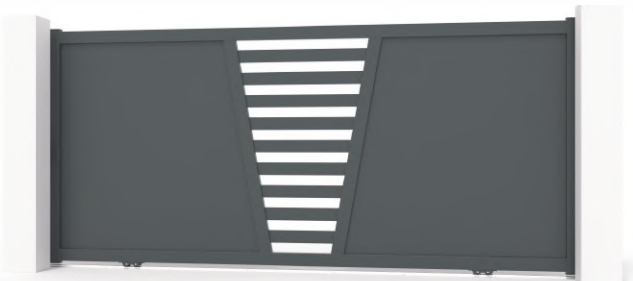

Lames | Slats
80x15mm

Panneau sandwich
Sandwich panel
3mm

Modèles | Models

PERFORMANCE ONE VERONA

PORTILLON GARDEN DOOR



PORTAIL BATTANT WINGED GARDEN GATE



PORTAIL COULISSANT SLIDING GATE



Modèles | Models

- NÉO VISION | BOLOGNA

DÉCORS | DECOR

NV1



NV2



NV3



NV4



NV5



NV6

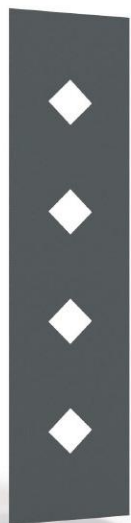

NV7



NV8

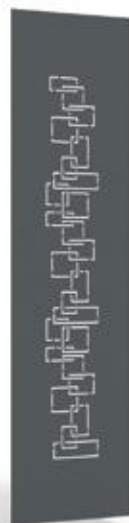

NV9



NV10







Modèles | Models

- NÉO VISION | BOLOGNA

DÉCORS | DECOR

NV13



NV14

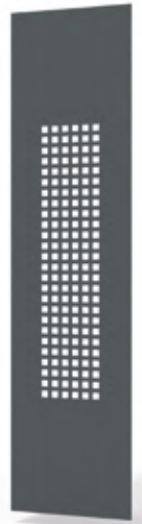

NV17



NV18

NV15



NV16



NV19



NV20



NV21



NV22



Modèles | Models

- NÉO VISION | BOLOGNA

DÉCORS | DECOR

NV23



NV24



NV25



NV26



NV27



NV28



NV29



NV30



NV31



NV32



Modèles | Models

- NÉO VISION TRI-ANGLE

DÉCORS | DECOR



NV3A1



NV3A2



NV3A3



NV3A4



NV3A5



NV3A6

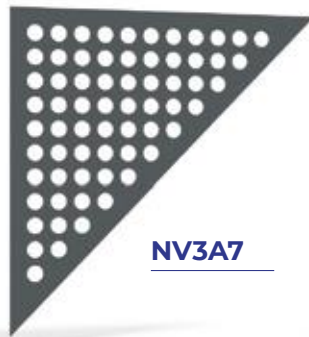

NV3A7



NV3A8

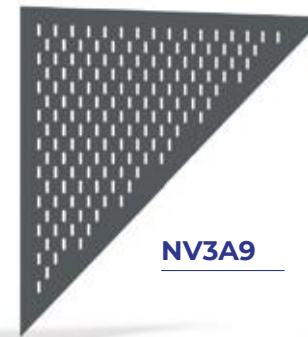

NV3A9

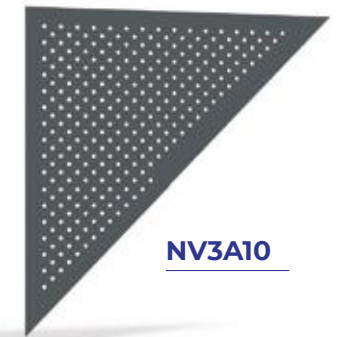

NV3A10

NV3ATI



NV3A12



Modèles | Models

- NÉO VISION TRI-ANGLE

DÉCORS | DECOR



NV3A13



NV3A14



NV3A17



NV3A18



NV3A15



NV3A16



NV3A19



NV3A20

NV3A21



NV3A22



Modèles | Models

- NÉO VISION TRI-ANGLE

DÉCORS | DECOR



NV3A23



NV3A25



NV3A26



NV3A27



NV3A28



NV3A29



NV3A30

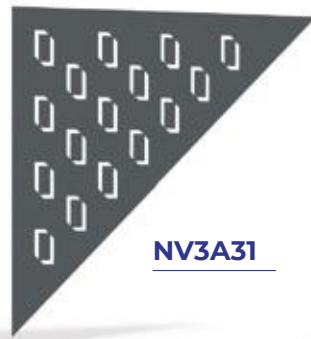

NV3A31



NV3A32

Modèles | Models

- TARN

DÉCORS | DECOR

CUNDA

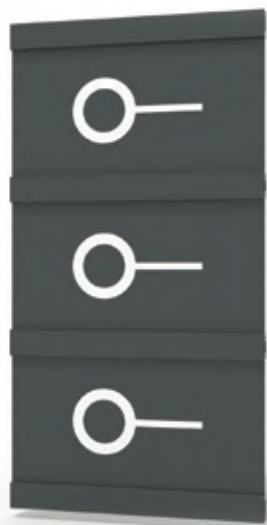

MOLAT



PAXOS



PIANOSA



VULCANO



ASSINARA
NORM.



Modèles | Models

- DIJON VERTICAL

DÉCORS | DECOR

CABRERA
NORM.



CABRERA
INV.



CORSE
NORM.



CORSE
INV.



ASSINARA
INV.



CORFOU
NORM.



CORFOU
INV.



LIPARI
NORM.



LIPARI
INV.

**MALTE
NORM.**



Modèles | Models

- DIJON VERTICAL

DÉCORS | DECOR

**PAXOS
NORM.**



**PAXOS
INV.**



**SICILE
NORM.**



**SICILE
INV.**



PIANOSA
NORM.



PIANOSA
INV.

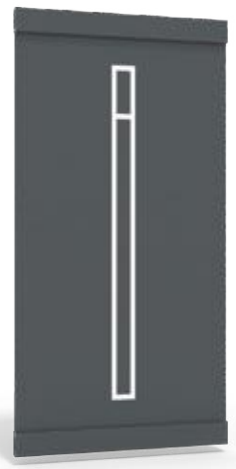

SILBA
NORM.

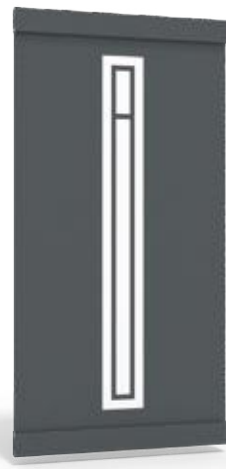

SILBA
INV.

MALTE
INV.



DP GEO 1



Modèles | Models

- DIJON PANNEAU

DÉCORS | DECOR

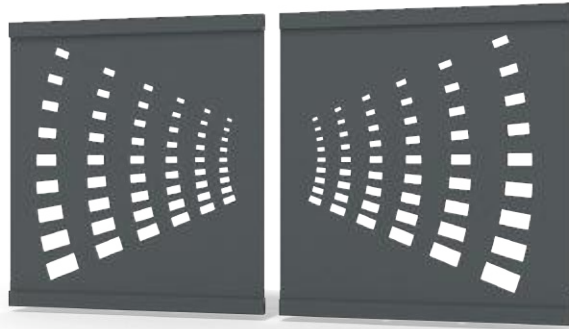

DP GEO 2

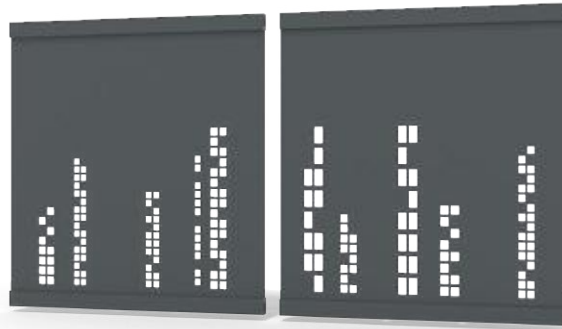

DP GEO 3

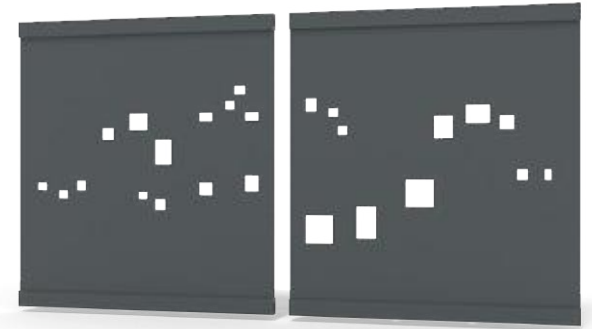

DP GEO 4

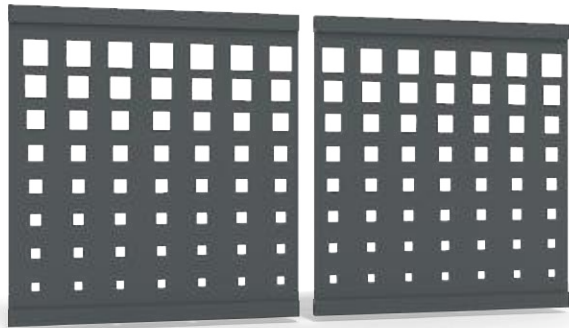

DP GEO 5

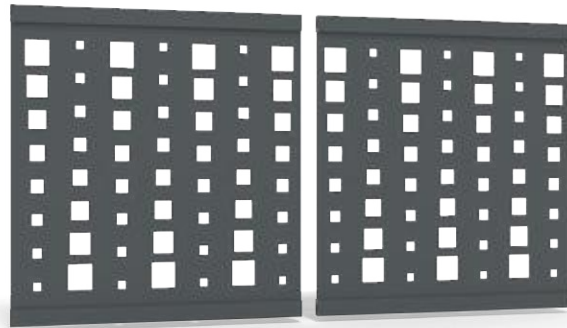

DP GEO 6

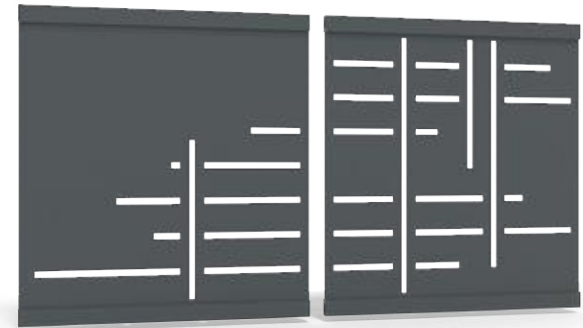

DP GEO 7

Modèles | Models

- DIJON PANNEAU

DÉCORS | DECOR

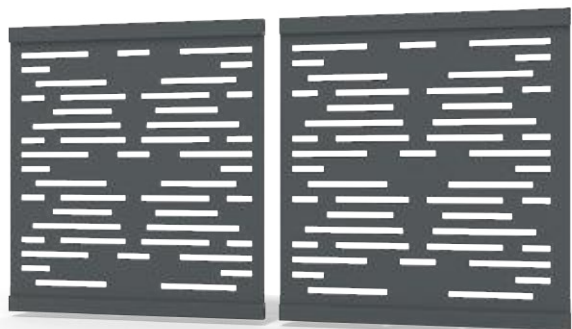

DP GEO 8

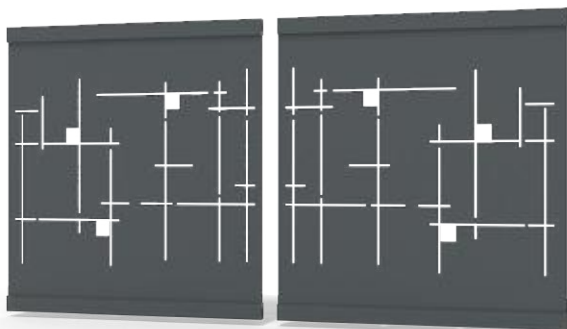

DP GEO 9

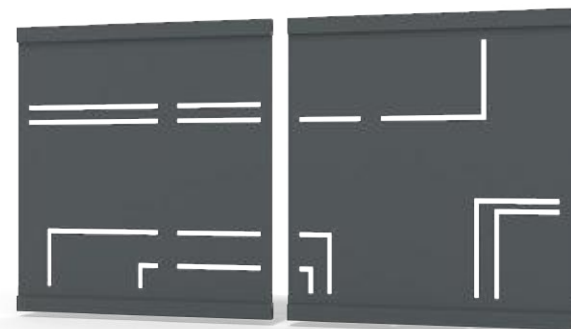

DP GEO 10

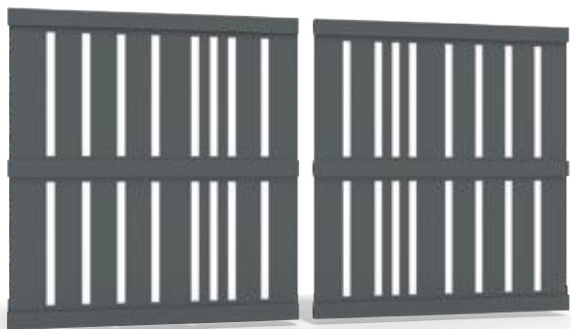

DP GEO 11

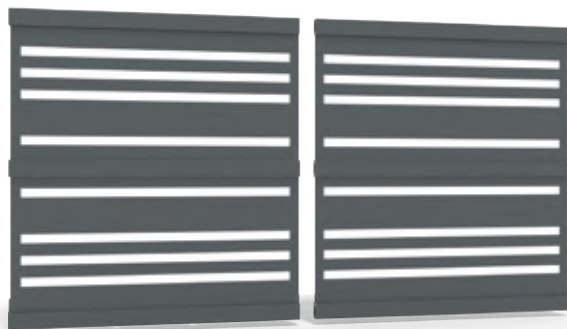

DP GEO 12

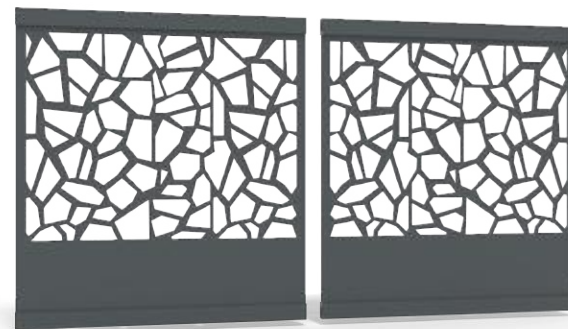

DP ORG 1

DP ORG 2



DP ORG 3



Modèles | Models

- DIJON PANNEAU

DÉCORS | DECOR

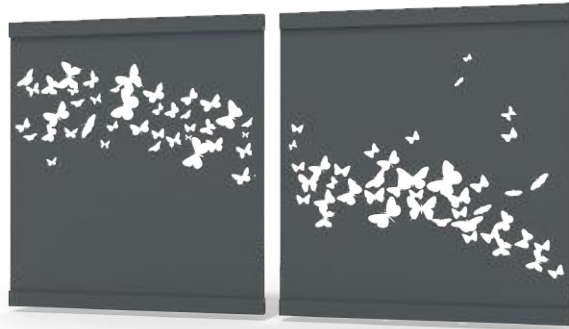

DP ORG 4

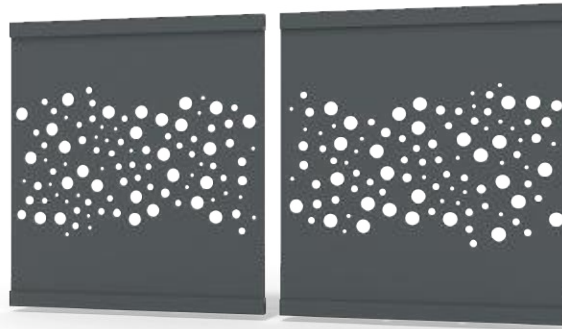

DP ORG 5

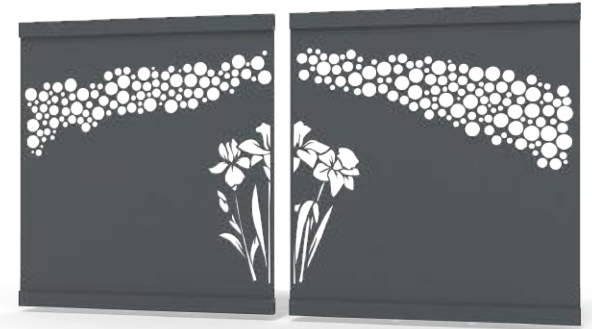

DP ORG 6

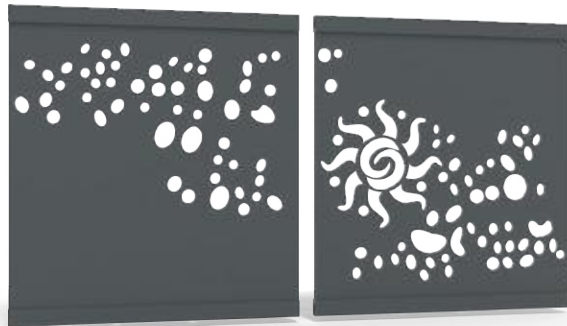

DP ORG 7



DP ORG 8

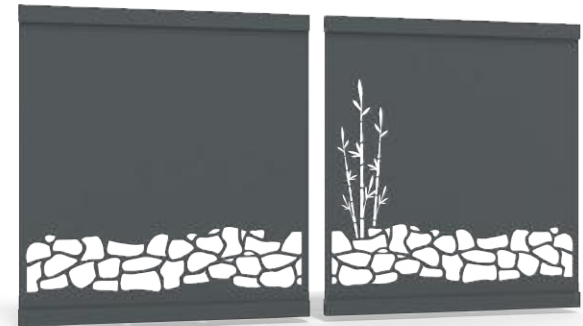

DP ORG 9



CLÔTURE FENCING

Caractéristiques | Characteristics

- Poteaux d'extrémités obligatoires
- Distance maxi entre poteaux: 2000mm
- Fixation transversale
- Platine à visser
- Chapeau plat

- Mandatory end post
- Maximum distance between posts: 2000mm
- Transverse fixing
- Screw-on base plate
- Flat cover

⚠ Attention: Au-delà de 1200mm de haut merci de sceller les poteaux (Poteau avec plus 300mm afin de sceller)

⚠ Attention: Beyond 1200mm high please sink the posts (Posts 300mm higher for sinking)

Modèles | Models

CLÔTURE | FENCING

REMPLISSAGE | FILL

100 VERTICAL

JURA/YONNE

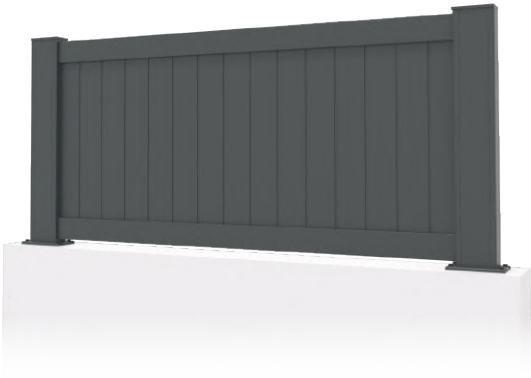

300 VERTICAL

AIN

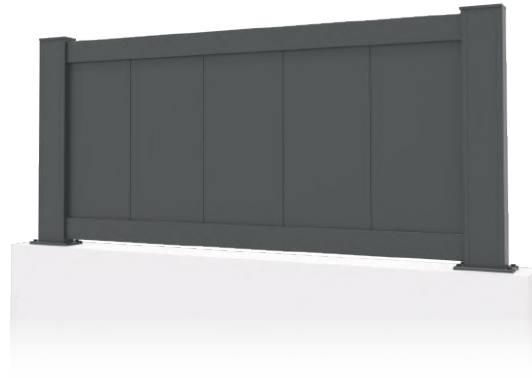

100 HORIZONTAL

GARD/CHER

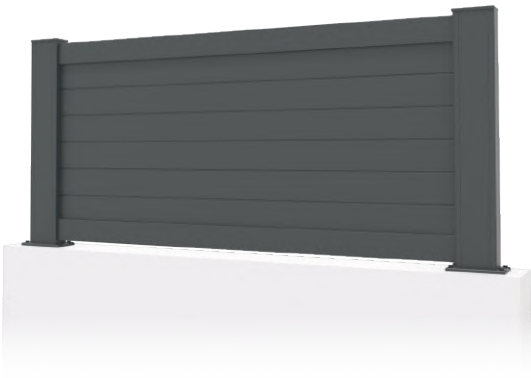

300 HORIZONTAL

ISÈRE



200 HORIZONTAL

MANCHE/LANDES OBLIQUE/NÉO VISION/
N. V. HORIZONTAL/N. V. OBLIQUE/
N. V. TRI-ANGLE/N. V. TRI-CENTRAL/



Modèles | Models

CLÔTURE | FENCING

REPLISSAGE | FILL

STRONG PERSIENNE

STRONG PERSIENNE

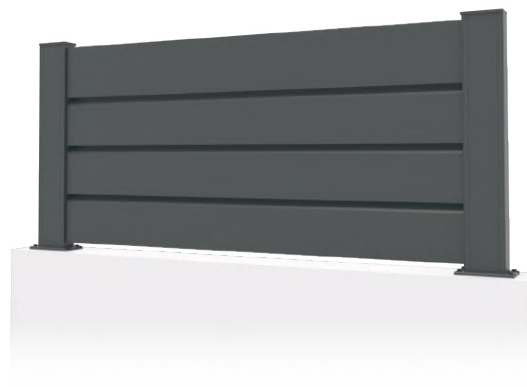

STRONG AJOURÉ

STRONG AJOURÉ

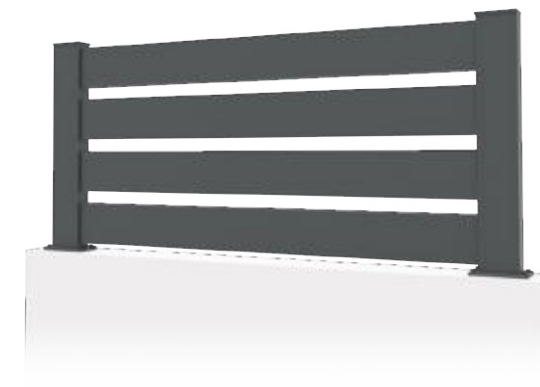

STRONG PLEIN

STRONG PLEIN

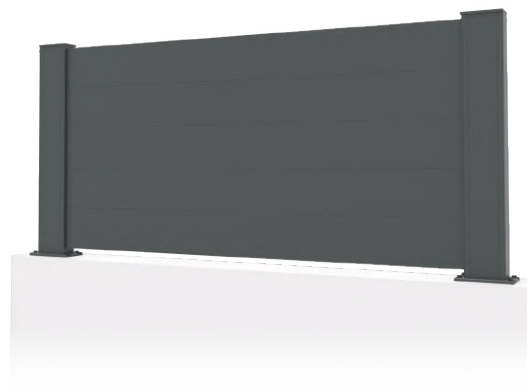

LANDES VERTICAL

LANDES VERTICAL

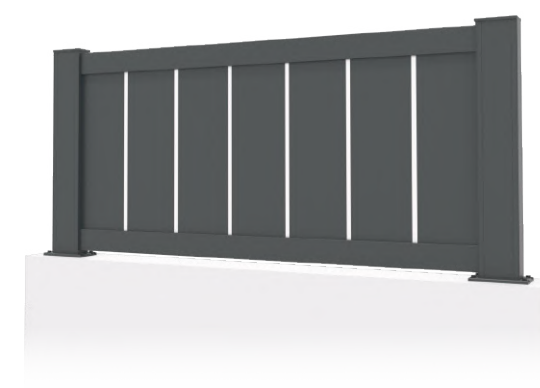

LANDES

LANDES



PANNEAU

TARN/DIJON VERTICAL/DIJON HORIZONTAL/
DIJON PANNEAU



30 VERTICAL

AUDE/MARNE

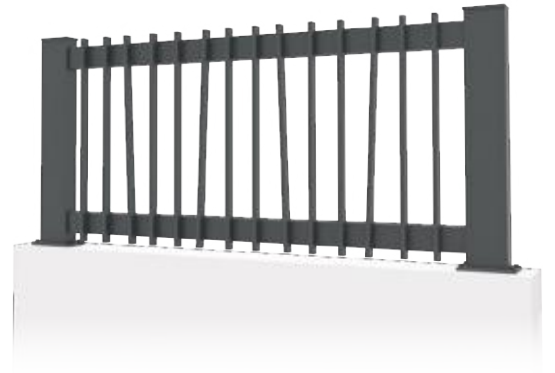

LANDES DOUBLE

LANDES DOUBLE

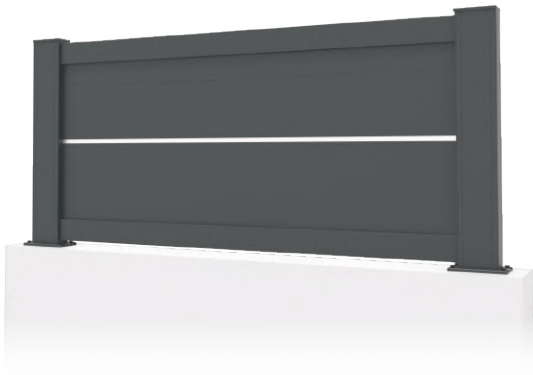

LOT

LOT



80 VERTICAL

CALVADOS/INDRE/CANTAL/OISE





CLÔTURES ET BRISE-VUE EN KIT FENCING AND PRIVACY SCREEN KIT

Caractéristiques | Characteristics

- Poteau vendu à l'unité, 120x64x1100mm ou 120x64x2300mm (à sceller), recoupable
- Lame vendu à l'unité 150x40x2000mm, recoupable
- Platine aluminium
- Pareclose à recouper

FICHE TECHNIQUE TECHNICAL SHEET

STRONG AJOURÉ

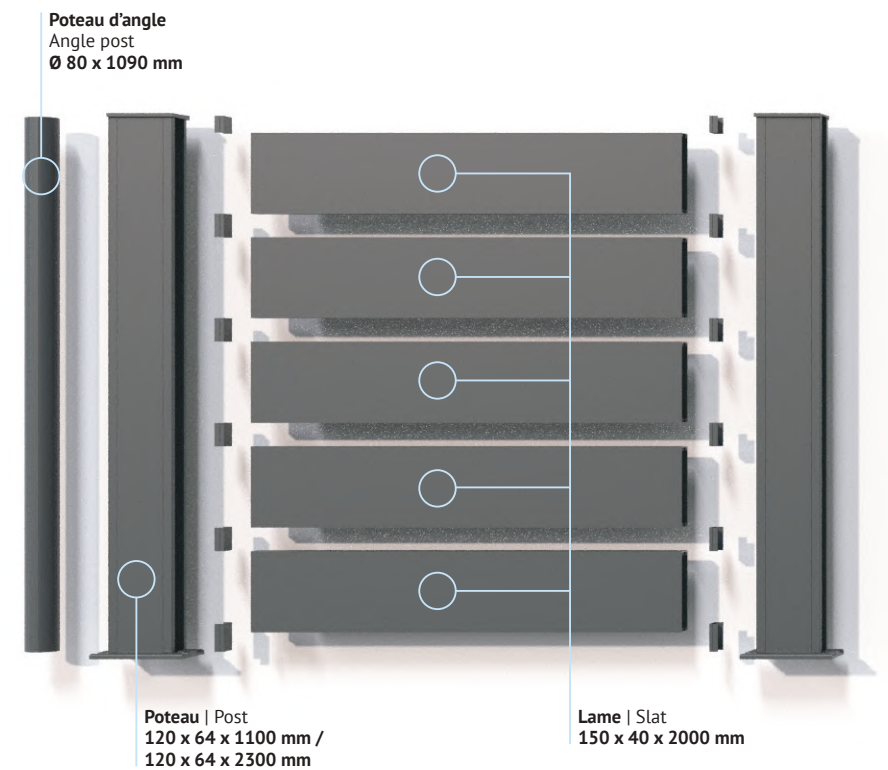

STRONG PERSIÈNNE

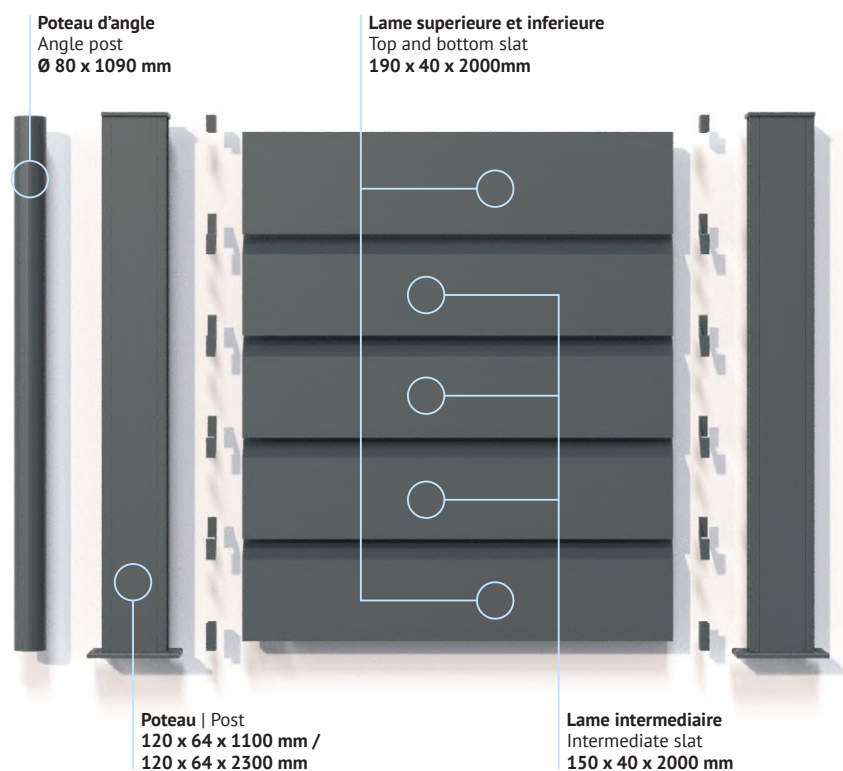

STRONG PLEIN

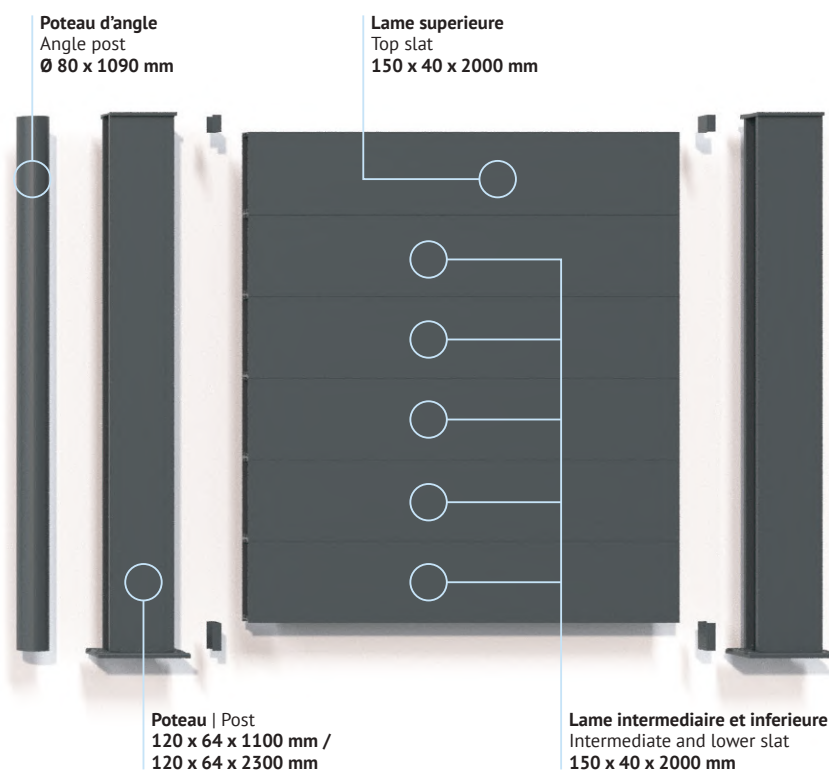

POTEAUX ALUMINIUM ALUMINIUM POST

Caractéristiques | Characteristics

- Poteaux aluminium 150x150mm ou 204x204mm, à sceller, complet
- Comprenant chapeau pointe de diamant et platine au sol
- Poteau livré sans le béton et sans ferrailage

- Aluminum poles 150x150mm or 204x204mm, to be sealed, complete
- Including diamond tip cover and floor plate
- Pole delivered without concrete and without reinforcement

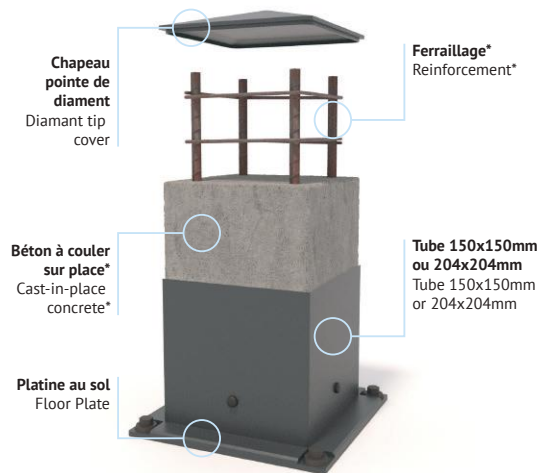



TOTEM POUR BOÎTE AUX LETTRES TOTEM FOR MAILBOX

Caractéristiques | Characteristics

- Deux poteaux de 2000mm de haut
- Onze lames gamme **STRONG PLEIN** 334 mm
- Possibilité de mettre une boîte aux lettres standard 300x300mm à la hauteur que vous souhaitez.

- Two posts 2000mm high
- Eleven slats **STRONG PLEIN** 334mm
- Possibility to put a standard letter box 300x300mm at the height you want.



PORTILLON INTÉGRÉ INTEGRATED GARDEN DOOR

Caractéristiques | Characteristics

- Serrure avec un point de fermeture
- Portillon toujours positionné en bout de portail coté fermeture
- Largeur standard 900mm cote de passage
- Cylindre européen
- Poussant droit pour un refoulement droit vue extérieur, poussant gauche pour un refoulement gauche vue extérieur

⚠ Attention à la marche, attention à la dimension de passage



CONCEPT PRESTIGE

Ouverture Télescopique | Telescopic opening

Caractéristiques | Characteristics

- Portail coulissant escamotable. Cette option permet d'installer un portail coulissant motorisé, même si vous disposez d'une zone de refoulement réduite. Ce portail est formé de deux vantaux qui se rabattent l'un sur l'autre et se superposent dans une zone de recul réduite.

- Retractable sliding gate. This option allows you to install a motorized sliding gate, even if you have a reduced discharge area. This gate consists of two leaves that fold one over another and are superimposed in a reduced recoil area.

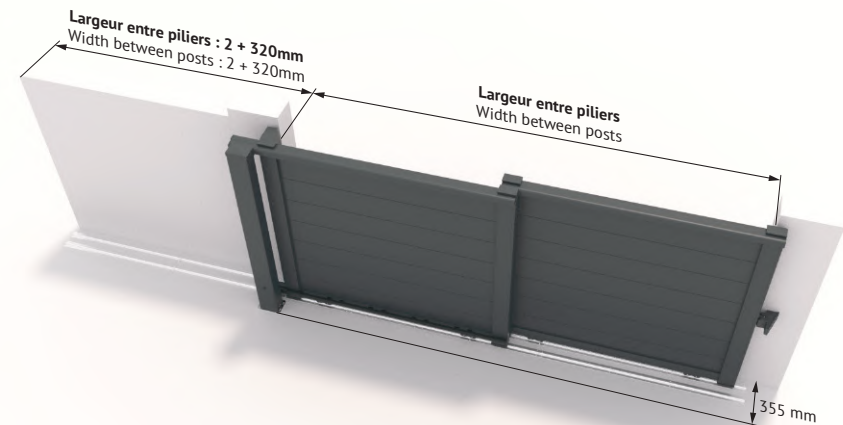

CONCEPT ARCHITECT

Cache jour entre le pilier et le portail
Cache day between the pillar and the gate

Caractéristiques | Characteristics

- En complément de votre portail ou portillon vous avez cette option de finition sur le montant coté pilier.
- Cette option permet donc d'améliorer la finition de votre portail/portillon avec un système avancé de rotation de l'axe d'ouverture, tout en maintenant les normes anti-pince doigts et en éliminant complètement le jour entre le pilier et le portail/portillon. Ouverture limitée à 120°.





CONCEPT DOUBLE OPEN

Caractéristiques | Characteristics

- Portail coulissant avec portillon attenant. Cette option vous permet d'entrer sans avoir à ouvrir complètement le portail. Ce portail comprend la motorisation

- Sliding gate with attached gate. This option allows you to enter without having to fully open the gate. This gate includes the motorization

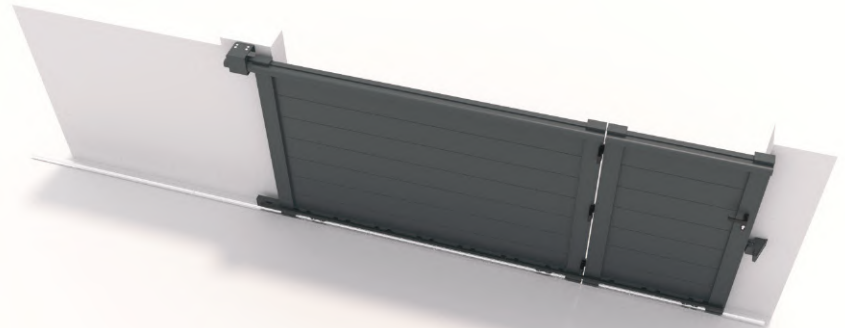



PORTE DE GARAGE

GARAGE DOOR

Porte de Garage Sectionnelle à Motoriser

Porte de Garage à Battant

Porte de Garage Enroulable Motorisée



PORTE DE GARAGE SECTIONNELLE À MOTORISER

SECTIONAL OVERHEAD GARAGE DOOR TO AUTOMATE

Caractéristiques | Characteristics

- Panneaux sandwich de 40mm, acier galva et peinture epoxy, mousse polyuréthane HD 48kg/m³, coef: 0,4W/m²k
- Forme anti-pince doigt
- Joint EPDM en fond de gorge
- Double épaisseur pour le renfort des charnières
- Capot acier sur chaque coté du panneau
- Profil alu bas avec joint de compression, et haut pour joint d'écrasement
- Charnières latérales industrielles renforcées type "Omega" et support de roues réglable en nylon
- Charnières centrales plates
- Platines basses à "queue de cochon" pour ajuster la tension du câble
- Axe de roulette en acier trempé et roulette en nylon sur roulement à billes
- Système de double rail galva anti-suspension avec courbe en acier galva
- Rivet tête écrasée
- Rail horizontaux avec support de cornière à ergots
- Barre d'écartement et joint d'étanchéité à glissement vertical
- Barre de torsion avec deux ressorts torsions et leur système anti-chute, quatre paliers raidisseurs à roulements à billes, deux poulies en zamac ou existe avec ressort de traction (retombé de linteau de 110mm)
- Portillon alu avec profil sans rivet apparent sur l'extérieur, charnière à crémaillère invisible et système anti-pince doigt
- Trois points de fermeture, seuil abaissé 30mm.

- 40mm sandwich panels, galvanized steel and epoxy paint, HD polyurethane foam 48kg/m³, coef: 0.4W/m²k
- Anti-finger trap protection
- EPDM seal at the bottom of the drain
- Double thickness for reinforcement of the hinges
- Steel hood on each side of the panel
- Aluminium profile bottom with compression seal, and top for crush seal
- Reinforced industrial side hinges type "OMEGA" and adjustable nylon wheel support
- Flat central hinges
- "Pig-tail" bottom plates to adjust the cable tension
- Hardened steel castor wheel and nylon castor on ball bearing
- Dual galvanized anti-suspension system with galvanized steel curve
- Rivet crushed head
- Horizontal rail with angled angle bracket
- Spreading bar and vertical sliding seal
- Torsion bar with two torsion springs and their anti-fall system, four bearings with ball bearings, two pulleys in zamac ou existe avec ressort de traction (retombé de linteau de 110mm)
- Aluminum door with profile without visible rivet on the outside, invisible rack hinge and anti-finger trap protection system
- Three closing points, threshold lowered 30mm.

Porte de Garage Sectionnelle à Motoriser
Sectional Overhead Garage Door to Automate

FICHE TECHNIQUE TECHNICAL SHEET

Résistance
au VENT
Resistance to
WIND



C3



Certifié ENAC - Laboratoire ENSATEC - CE NB 1668 n° de organisme notifié
Classement - VENT C3
Forces de manoeuvre: Confirmée
EN 13241-1
Certified ENAC - Laboratory ENSATEC - CE NB 1668 notified entity number
Ranking - Wind C3
Operating forces: Confirmed
EN 13241-1





Modèles | Models

Porte de Garage Sectionnelle à Motoriser | Sectional Overhead Garage Door to Automate

DÉCOR ALUNOX À COLLER | DECOR ALUNOX TO PASTE

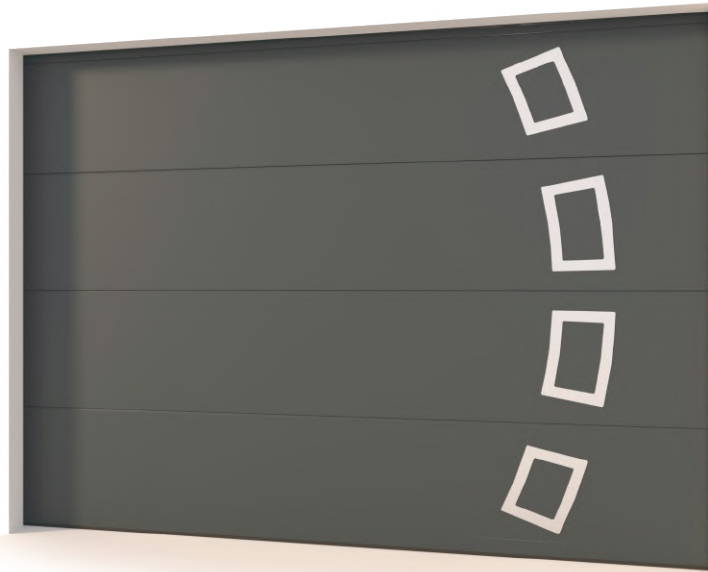

PIANOSA NORM.



PIANOSA INV.



VULCANO





PAXOS NORM.

Modèles | Models

Porte de Garage Sectionnelle à Motoriser | Sectional Overhead Garage Door to Automate

DÉCOR ALUNOX À COLLER | DECOR ALUNOX TO PASTE



PAXOS INV.



MOLAT NORM.



MOLAT INV.



CUNDA NORM.



Modèles | Models

Porte de Garage Sectionnelle à Motoriser | Sectional Overhead Garage Door to Automate

DÉCOR ALUNOX À COLLER | DECOR ALUNOX TO PASTE



CUNDA INV.



PAXOS PLUS





PORTE DE GARAGE À BATTANT SÉRIE FROIDE

GARAGE DOOR SIDE HINGED COLD SERIES

Sans rupture de pont thermique | Without thermal break

Caractéristiques | Characteristics

- Panneaux sandwich de 30mm
 - Laquage sur profil aluminium label Qualicoat / Qualimarine / Qualanod
 - Serrure cinq points de fermeture deux crémones haute et basse, quatre galets de compression, un point dit de sécurité, et deux points anti-dégondages inox coté opposé, système de tringlerie par polyamide renforcée
 - Paumelle à clamor
 - Cylindre européen avec trois clefs (Option: serrure avec cinq clefs et carte de propriété)
 - Triple joint sur le système d'ouverture
 - Seuil à rupture de pont thermique PMR anodisé, double joint
 - Système de rejet d'eau anodisé
 - Équerre de serrage par compression vissée, équerrage des angles par équerre inox ouvrant et dormant
 - Poignée alu avec cache cylindre indépendant
- Sandwich panels of 30mm
 - Lacquering on aluminum profile Qualicoat / Qualimarine / Qualanod
 - Five-point lock, two locking bolts top and bottom, four compression rollers, one fix safety point, two anti-unhinging points inox on opposite sides, linkage system with reinforced polyamide
 - Cramp hinges
 - European cylinder with three keys (Option: lock with five keys and property card)
 - Triple seal on the opening system
 - Threshold with thermal break, PMR, anodized, double joint
 - Anodized water discharge system
 - Bolt-on compression clamping bracket, square angle brackets by opening and closing stainless steel bracket
 - Aluminum handles with independent cylinder cover



Certifié ENAC - Laboratoire ENSATEC - CE NB 1668 n° de organisme notifié
 EN 14351-1
 Certified ENAC - Laboratory ENSATEC - CE NB 1668 notified entity number
 EN 14351-1



PORTE DE GARAGE | GARAGE DOOR



PORTE DE GARAGE À BATTANT

GARAGE DOOR SIDE HINGED

ONDULINE

Caractéristiques | Characteristics

- Panneaux sandwich de 30mm
 - Laquage sur profil aluminium label Qualicoat / Qualimarine / Qualanod
 - Ouvrant rpth barrette polyamide renforcée de fibre de verre, profil sans parecloses
 - Serrure sept points de fermeture deux crémones haute et basse, quatre galets de compression, un point dit de sécurité, et deux points anti-dégondages inox coté opposé, système de tringlerie par polyamide renforcée
 - Paumelle à clamots
 - Cylindre européen avec trois clefs (Option: serrure avec cinq clefs et carte de propriété)
 - Dormant 63mm RPTH barrette polyamide renforcée de fibres de verre, système intégré d'habillage extérieur ou de tapée
 - Triple joint sur le système d'ouverture
 - Seuil à rupture de pont thermique PMR anodisé, double joint
 - Système de rejet d'eau anodisé
 - Equerre de serrage par compression vissée, équerrage des angles par équerre inox ouvrant et dormant
 - Poignée alu avec cache cylindre indépendant
 - Ud: jusqu'à 1,7W/m².k
- Sandwich panels of 30mm
 - Lacquering on aluminum profile Qualicoat / Qualimarine / Qualanod
 - Opening (RPT) thermal break polyamide strip reinforced with fibreglass, profile without beads
 - Seven-point lock, two locking bolts top and bottom, four compression rollers, one fix safety point, two anti-unhinging points inox on opposite sides, linkage system with reinforced polyamide
 - Cramp hinges
 - European cylinder with three keys (Option: lock with five keys and property card)
 - Frame 63mm, (RPT) thermal break polyamide strip reinforced with fibreglass, integrated external cladding system or jamb cover
 - Triple seal on the opening system
 - Threshold with thermal break, PRM, anodized, double joint
 - Anodized water discharge system
 - Bolt-on compression clamping bracket, square angle brackets by opening and closing stainless steel bracket
 - Aluminum handles with independent cylinder cover
 - Ud: up to 1,7W/m².k



Certifié ENAC - Laboratoire ENSATEC - CE NB 1668 n° de organisme notifié
 EN 14351-1
 Certified ENAC - Laboratory ENSATEC - CE NB 1668 notified entity number
 EN 14351-1



PORTE DE GARAGE À BATTANT

GARAGE DOOR SIDE HINGED

ARCHITECT

Caractéristiques | Characteristics

- Panneaux sandwich de 30mm
 - Laquage sur profil aluminium label Qualicoat / Qualimarine / Qualanod
 - Ouvrant rpth barrette polyamide renforcée de fibre de verre, profil sans parecloses
 - Serrure sept points de fermeture deux crémones haute et basse, quatre galets de compression, un point dit de sécurité, et deux points anti-dégondages inox coté opposé, système de tringlerie par polyamide renforcée
 - Paumelle à clamots
 - Cylindre européen avec trois clefs (Option: serrure avec cinq clefs et carte de propriété)
 - Dormant 63mm RPTH barrette polyamide renforcée de fibres de verre, système intégré d'habillage extérieur ou de tapée
 - Triple joint sur le système d'ouverture
 - Seuil à rupture de pont thermique PMR anodisé, double joint
 - Système de rejet d'eau anodisé
 - Equerre de serrage par compression vissée, équerrage des angles par équerre inox ouvrant et dormant
 - Poignée alu avec cache cylindre indépendant
 - Ud: jusqu'à 1,7W/m².k
- Sandwich panels of 30mm
 - Lacquering on aluminum profile Qualicoat / Qualimarine / Qualanod
 - Opening (RPT) thermal break polyamide strip reinforced with fibreglass, profile without beads
 - Seven-point lock, two locking bolts top and bottom, four compression rollers, one fix safety point, two anti-unhinging points inox on opposite sides, linkage system with reinforced polyamide
 - Cramp hinges
 - European cylinder with three keys (Option: lock with five keys and property card)
 - Frame 63mm, (RPT) thermal break polyamide strip reinforced with fibreglass, integrated external cladding system or jamb cover
 - Triple seal on the opening system
 - Threshold with thermal break, PRM, anodized, double joint
 - Anodized water discharge system
 - Bolt-on compression clamping bracket, square angle brackets by opening and closing stainless steel bracket
 - Aluminum handles with independent cylinder cover
 - Ud: up to 1,7W/m².k



Certifié ENAC - Laboratoire ENSATEC - CE NB 1668 n° de organisme notifié
EN 14351-1
Certified ENAC - Laboratory ENSATEC - CE NB 1668 notified entity number
EN 14351-1



PORTE DE GARAGE | GARAGE DOOR

ENTWURF | VE | BSG SELLSCHAFT





PORTE DE GARAGE À BATTANT

GARAGE DOOR SIDE HINGED

DEUTSCHE QUALITÄT

Caractéristiques | Characteristics

- Ouvrant monobloc 65mm
 - Parement d'aluminium avec fraisage
 - Laquage label Qualicoat / Qualimarine / Qualanod
 - Panneau en mousse de polystyrène extrudé compressée entre deux panneaux de contreplaqué en bois PEFC
 - Vitrage 33² SABLÉ, 20 GAZ, 6 FE, 20 GAZ, 6 SABLÉ
 - Ouvrant R-P.TH barrette polyamide renforcée de fibres de verre, profil sans close
 - Deux points anti-dégondage inox coté opposé
 - Paumelle Dr. Hahn, réglable
 - Crémone crochet automatique magnétique de trois points
 - Dormant 58mm RPTH barrette polyamide renforcée de fibres de verre
 - Profil pouvant accepter une tapée d'isolation et une aile de recouvrement intérieure
 - Triple joint sur le système d'ouverture
 - Seuil à rupture de pont thermique PMR anodisé
 - Système de rejet d'eau anodisé
 - Équerre de serrage par compression vissée, équerrement des angles par équerre inox ouvrant et dormant
 - Poignée inox et rosace
 - Aluminium 100% RECYCLABLE
- Monoblock Opening 65mm
 - Aluminium facing with milling
 - Coating Label Qualicoat / Qualimarine / Qualanod
 - Extruded Polystyrene foam board compressed between two plywood panels PEFC
 - Glazing 33² SANDED, 20 GAZ, 6 FE, 20 GAZ, 6 SANDED
 - Opening (RPT) thermal break polyamide strip reinforced with fibreglass, profile without beads
 - Two anti-unhinging points inox on opposite sides
 - Dr. Hahn adjustable hinge
 - Three-point magnetic automatic hook lock
 - Frame 58mm, (RPT) thermal break polyamide strip reinforced with fibreglass
 - Profile can accept a jamb insulation and an inner covering wing
 - Triple joint on the opening system
 - Threshold with thermal break, PMR, anodized
 - Anodized water discharge system
 - Corner brackets joint by screw-compression, stainless steel angle brackets on frame and opening
 - Stainless Steel Handle
 - 100% RECYCLABLE Aluminium



Certifié ENAC - Laboratoire ENSATEC - CE NB 1668 n° de organisme notifié
EN 14351-1

Certified ENAC - Laboratory ENSATEC - CE NB 1668 notified entity number
EN 14351-1

FICHE TECHNIQUE | TECHNICAL SHEET

SÉRIE FROIDE | COLD SERIES

ONDULINE

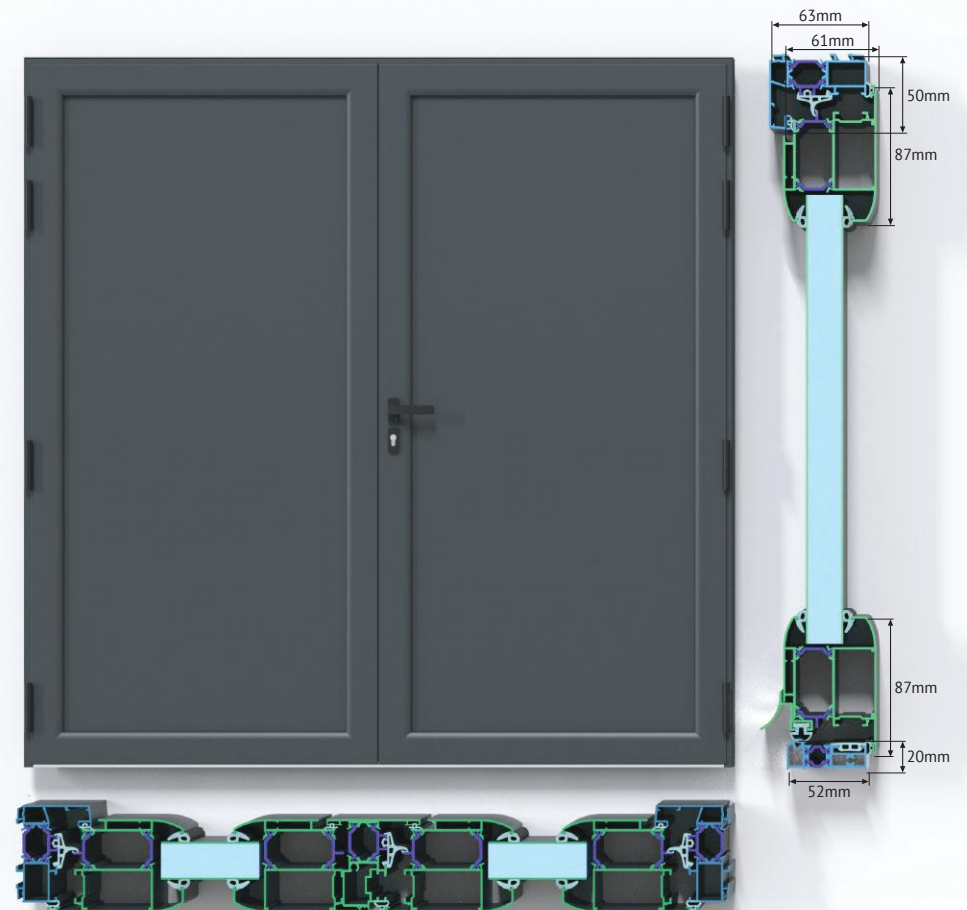
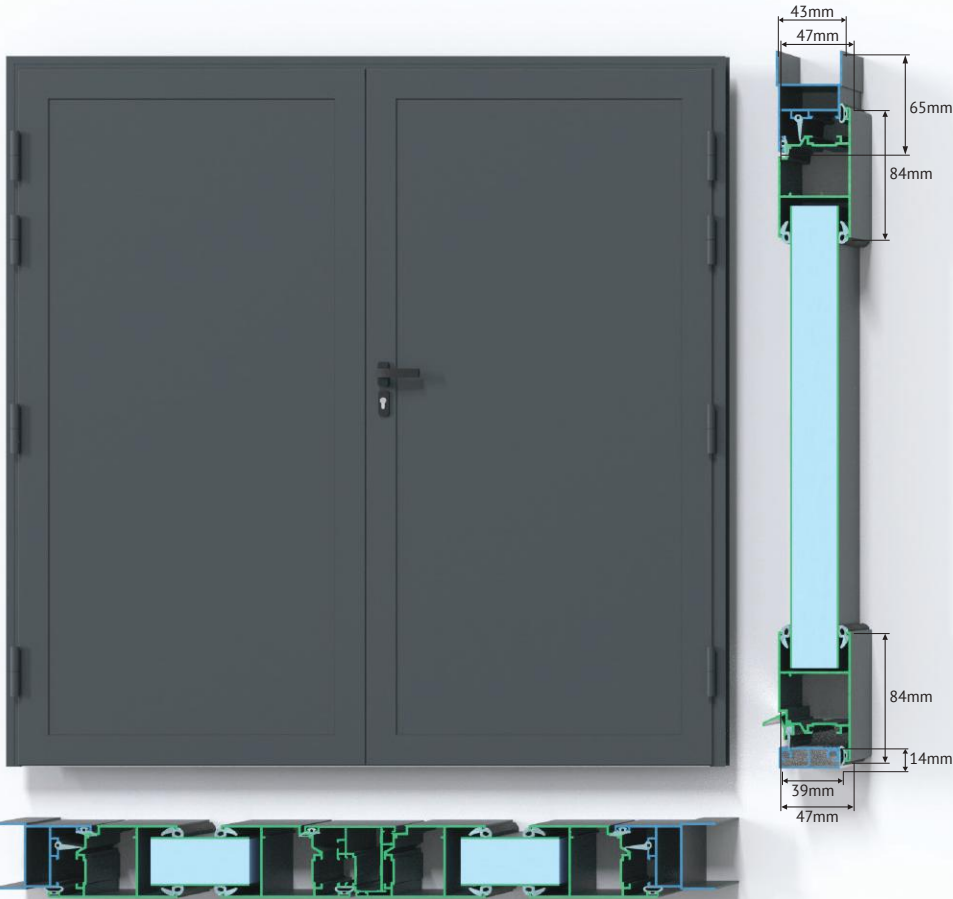

Étanchéité à l'AIR
AIR-tightness



2

Perméabilité à l'EAU
Permeability to WATER



4A

Résistance au VENT
Resistance to WIND



A1

Étanchéité à l'AIR
AIR-tightness

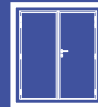

3

Perméabilité à l'EAU
Permeability to WATER



1A

Résistance au VENT
Resistance to WIND



C4

Conductivité THERMIQUE
Thermal CONDUCTIVITY



1,7 w/m².k

ARCHITECT

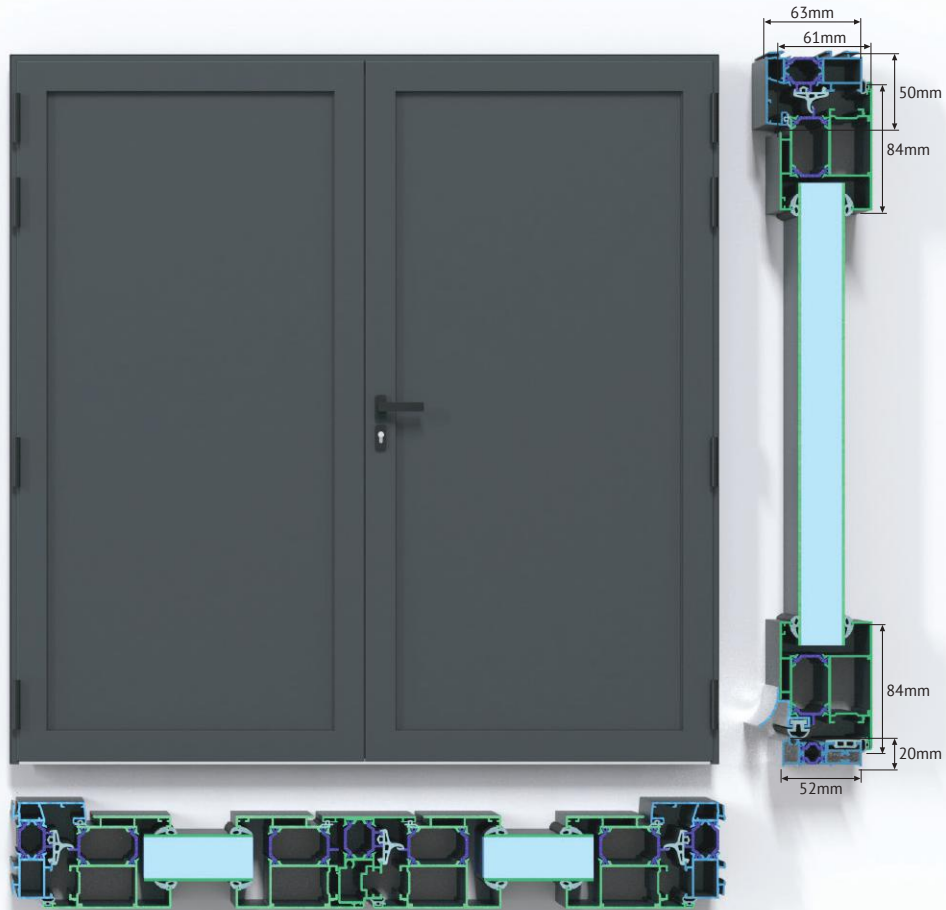

Étanchéité à l'AIR
AIR-tightness



3

Perméabilité à l'EAU
Permeability to WATER



1A

Résistance au VENT
Resistance to WIND



C4

Conductivité THERMIQUE
Thermal CONDUCTIVITY



1,7 w/m².k

DEUTSCHE QUALITÄT 

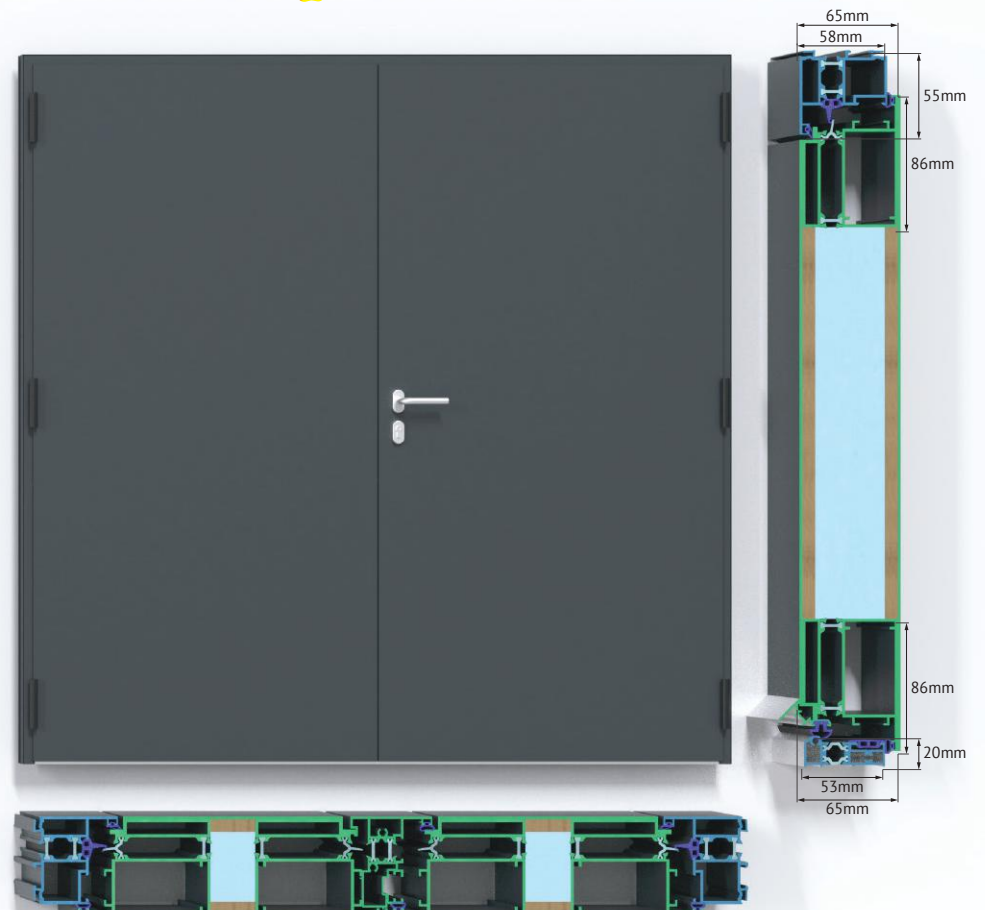

Étanchéité à l'AIR
AIR-tightness



3

Perméabilité à l'EAU
Permeability to WATER



1A

Résistance au VENT
Resistance to WIND



C4

Conductivité THERMIQUE
Thermal CONDUCTIVITY



1,4 w/m².k

Modèles | Models

Porte de Garage à Battant | Garage Door Side Hinged

HUBLLOT | PORTHOLE

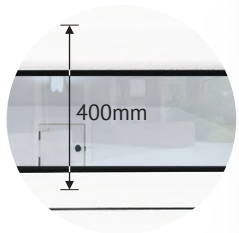

HUBLLOT CLAIR PORTHOLE CLEAR

- Hauteur standard 400mm (clair de jour: 277mm)
- Vitrage 4 FE, 12 GAZ, 44² WGE
- Height standard 400mm (daylight: 277mm)
- Glass 4 FE, 12 GAZ, 44² WGE

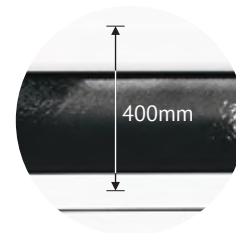

HUBLLOT SABLÉ PORTHOLE SANDED

- Hauteur standard 400mm (clair de jour: 277mm)
- Vitrage 4 FE, 12 GAZ, 44² WGE
- Sablé ou granité
- Height standard 400mm (daylight: 277mm)
- Glass 4 FE, 12 GAZ, 44² WGE
- Sandblasted or granit



Modèles | Models

Porte de Garage à Battant | Garage Door Side Hinged

AVEC DÉCOR | WITH DECOR
GAMME CONTEMPORAINE | RANGE CONTEMPORAINE

SICILE

SICILE ALUNOX



Modèles | Models

Porte de Garage à Battant | Garage Door Side Hinged

AVEC DÉCOR | WITH DECOR
GAMME CONTEMPORAINE | RANGE CONTEMPORAINE



CAPRERA ALUNOX



CORFOU



CORFOU ALUNOX

Modèles | Models

Porte de Garage à Battant | Garage Door Side Hinged

AVEC DÉCOR | WITH DECOR
GAMME CONTEMPORAINE | RANGE CONTEMPORAINE

GOZO ALUNOX



LIPARI ALUNOX



ASINARA ALUNOX



Modèles | Models

Porte de Garage à Battant | Garage Door Side Hinged

AVEC DÉCOR | WITH DECOR
GAMME CONTEMPORAINE | RANGE CONTEMPORAINE



ZANTE ALUNOX 1



ZANTE ALUNOX 2



ZANTE ALUNOX 3

Modèles | Models

Porte de Garage à Battant | Garage Door Side Hinged

AVEC DÉCOR | WITH DECOR
GAMME CONTEMPORAINE | RANGE CONTEMPORAINE



SARIA ALUNOX



LUNDY



KALAMOS ALUNOX

Modèles | Models

Porte de Garage à Battant | Garage Door Side Hinged

AVEC DÉCOR | WITH DECOR
GAMME CONTEMPORAINE | RANGE CONTEMPORAINE



VULCANO ALUNOX



TILOS ALUNOX PLUS



TILOS ALUNOX

Modèles | Models

Porte de Garage à Battant | Garage Door Side Hinged

AVEC DÉCOR | WITH DECOR
GAMME CONTEMPORAINE | RANGE CONTEMPORAINE

SANTORINI



RINIA



RINIA ALUNOX



Modèles | Models

Porte de Garage à Battant | Garage Door Side Hinged

AVEC DÉCOR | WITH DECOR
GAMME CONTEMPORAINE | RANGE CONTEMPORAINE

MONTECRISTO



DIA ALUNOX



IBIZA



Modèles | Models

Porte de Garage à Battant | Garage Door Side Hinged

AVEC DÉCOR | WITH DECOR
GAMME CONTEMPORAINE | RANGE CONTEMPORAINE



MADEIRA ALUNOX



SILBA ALUNOX



CAPRAIA

Modèles | Models

Porte de Garage à Battant | Garage Door Side Hinged

AVEC DÉCOR | WITH DECOR
GAMME CONTEMPORAINE | RANGE CONTEMPORAINE

ANDROS



CORSE



CORSE ALUNOX



Modèles | Models

Porte de Garage à Battant | Garage Door Side Hinged

AVEC DÉCOR | WITH DECOR
GAMME CONTEMPORAINE | RANGE CONTEMPORAINE

CAPRI



PAXOS



PAXOS ALUNOX



Modèles | Models

Porte de Garage à Battant | Garage Door Side Hinged

AVEC DÉCOR | WITH DECOR
GAMME CONTEMPORAINE | RANGE CONTEMPORAINE



KASSOS ALUNOX



RHODES ALUNOX



LEUCADE ALUNOX

Modèles | Models

Porte de Garage à Battant | Garage Door Side Hinged

AVEC DÉCOR | WITH DECOR
GAMME CONTEMPORAINE | RANGE CONTEMPORAINE



AÇORES ALUNOX



VIR ALUNOX



SAMOS

Modèles | Models

Porte de Garage à Battant | Garage Door Side Hinged

AVEC DÉCOR | WITH DECOR
GAMME CONTEMPORAINE | RANGE CONTEMPORAINE

MOLAT



MOLAT ALUNOX



PIANOSA ALUNOX



Modèles | Models

Porte de Garage à Battant | Garage Door Side Hinged

AVEC DÉCOR | WITH DECOR
GAMME CONTEMPORAINE | RANGE CONTEMPORAINE

CUNDA



CUNDA ALUNOX



SALINA



Modèles | Models

Porte de Garage à Battant | Garage Door Side Hinged

AVEC DÉCOR | WITH DECOR
GAMME CONTEMPORAINE | RANGE CONTEMPORAINE



CABRERA

CABRERA ALUNOX

Modèles | Models

Porte de Garage à Battant | Garage Door Side Hinged

AVEC DÉCOR | WITH DECOR
GAMME CONTEMPORAINE | RANGE CONTEMPORAINE

LAMPEDUSA

MALTE ALUNOX





PORTE DE GARAGE ENROULABLE MOTORISÉE

AUTOMATED ROLLER GARAGE DOOR

Caractéristiques | Characteristics

- **Lame de 55mm ou 77mm aluminium isolé par mousse polyuréthane**
 - **Moteur tubulaire NFI ou Somfy et récepteur avec deux télécommandes**
 - **Photocellules**
 - **Système anti-chute**
 - **Caisson de 250mm ou 300mm en aluminium à pan coupé 45°**
 - **Coulisse avec joint caoutchouc**
 - **Tulipe de guidage**
 - **Verrou autoblocant**
 - **Résistance au vent classe 6 (lame 77mm) ou classe 3 (lame 55mm)**
 - **Manoeuvre de secours par manivelle**
- Slat 55mm or 77mm aluminum insulated by polyurethane mouse
 - NFI or Somfy tubular motor and receiver with two remotes
 - Photocells
 - Anti-fall system
 - 250mm or 300mm aluminum housing with 45° cut-out
 - Slide with rubber seal
 - Tulip guide
 - Self-locking bolt
 - Wind resistance class 6 (slat 77mm) or class 3 (slat 55mm)
 - Crank emergency maneuver